

Druckregler - Serie N

Produktcode: N1204-R21

Datenblatt Erstellungsdatum: 21.05.26 02:12

Überprüfen Sie das aktualisierte Dokument  [klicken](#)



TECHNISCHE DATEN

Mod.	N1204-R21
R (mm)	3
U	G1/4

Druckregler - Serie N

Produktcode: N1204-R21

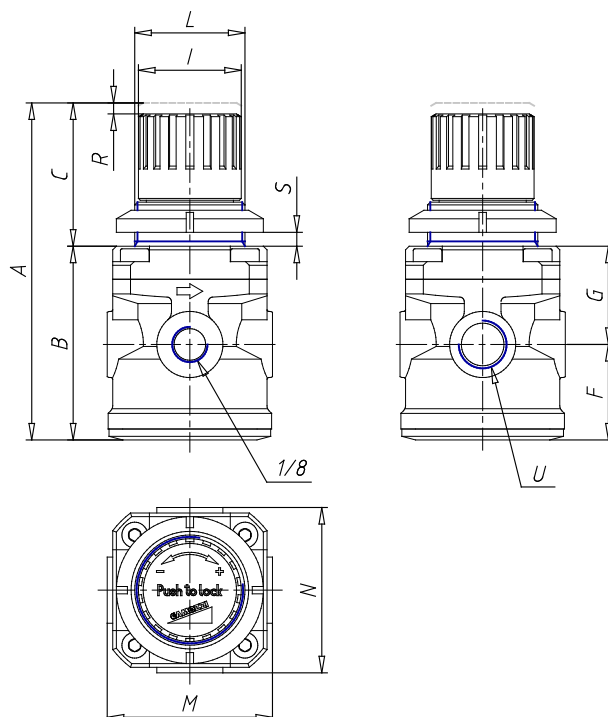

MAßE

A (mm)	92
Gewindelaenge (mm)	53
C (mm)	39
F (mm)	26
G (mm)	27
I (mm)	28
leicht (mm)	30x1.5
M (mm)	45
N (mm)	45