

Öler - Serie N

Produktcode: N208-L00

Datenblatt Erstellungsdatum: 21.05.26 01:25

Überprüfen Sie das aktualisierte Dokument [klicken](#)



TECHNISCHE DATEN

Mod.	N208-L00
------	----------

Öler - Serie N

Produktcode: N208-L00

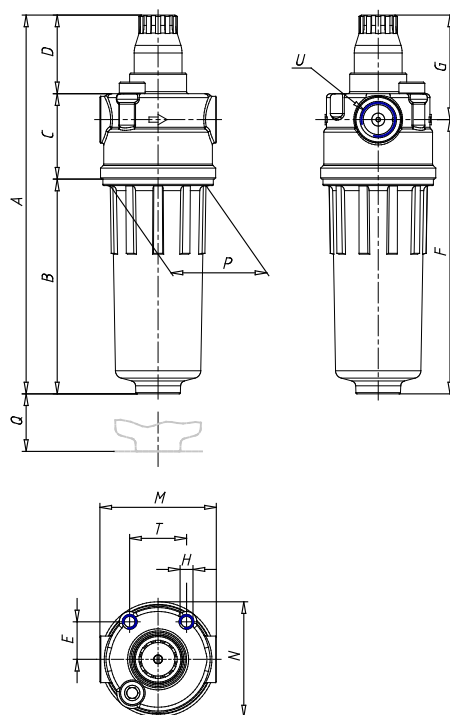

MAßE

A (mm)	146.5
B (mm)	83
C (mm)	33
D (mm)	30.5
E (mm)	14.5
F (mm)	106
G (mm)	40.5
H	M5
M (mm)	45
N (mm)	44.5
P (mm)	38
Q (mm)	46.5
T (mm)	22
U	G1/8