

Fussbefestigung/Flansch - Mod. P

Produktcode: P-42-63

Datenblatt Erstellungsdatum: 20.05.26 16:53

Überprüfen Sie das aktualisierte Dokument  [klicken](#)



TECHNISCHE DATEN

| | |
|------|---------|
| Mod. | P-42-63 |
|------|---------|

Fussbefestigung/Flansch - Mod. P

Produktcode: P-42-63

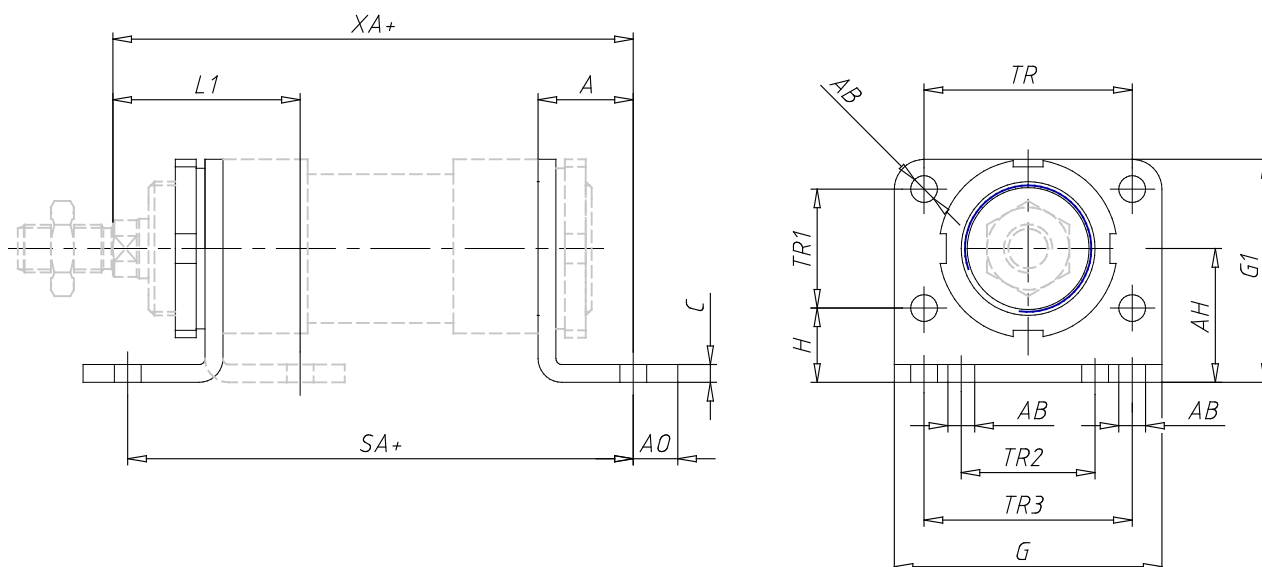

MAßE

| | |
|----------|-----|
| L1 (mm) | 63 |
| SA (mm) | 185 |
| XA (mm) | 190 |
| A (mm) | 32 |
| AB (mm) | 9 |
| AO (mm) | 10 |
| AH (mm) | 50 |
| C (mm) | 6 |
| G (mm) | 96 |
| G1 (mm) | 85 |
| TR (mm) | 76 |
| TR1 (mm) | 50 |
| TR2 (mm) | 50 |
| TR3 (mm) | 76 |
| H (mm) | 25 |