

Motor-Verbindungs-Kit, parallel - Mod. PM

Produktcode: PM-3E-32-0024

Datenblatt Erstellungsdatum: 21.05.26 09:28

Überprüfen Sie das aktualisierte Dokument  [klicken](#)



TECHNISCHE DATEN

Mod.	PM-3E-32-0024
Motor	MTS-24-...
Schutz	IP40

Motor-Verbindungs-Kit, parallel - Mod. PM

Produktcode: PM-3E-32-0024

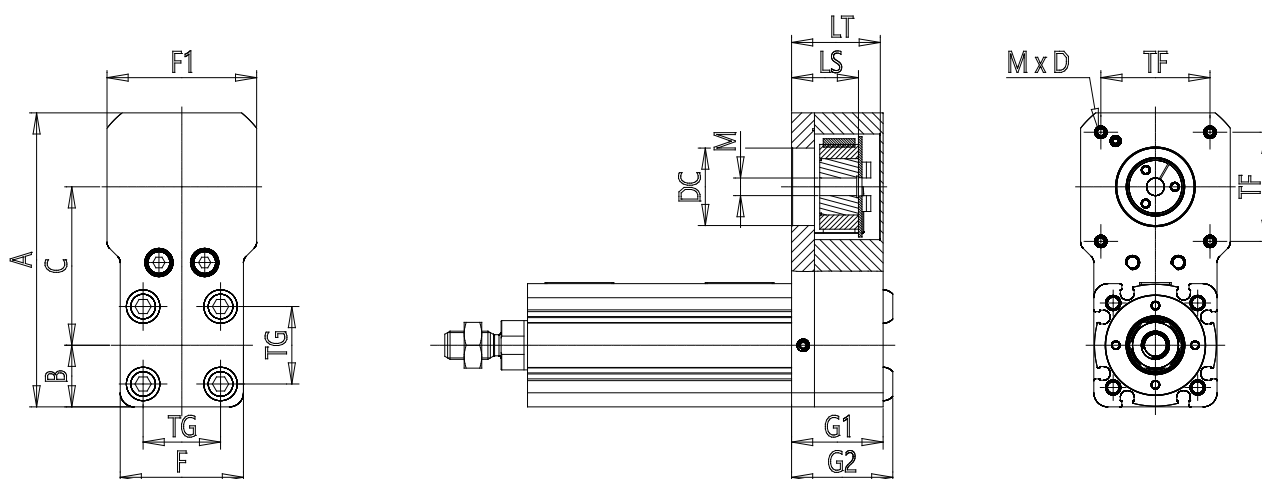

MAßE

A (mm)	116.5
B (mm)	21.0
C (mm)	67.5
F (mm)	42
F1 (mm)	56.5
TG (mm)	32.5
G1 (mm)	28
G2 (mm)	31.0
DC (mm)	38.1
M (mm)	8.00
LS (mm)	19
LT (mm)	26.5
TF (mm)	47.14
MxD	M4x6
J (kgmm ²)	5.84
Gewicht (g)	390