

Motor-Verbindungs-Kit, parallel, Mod. PM - Mod. PM

Produktcode: PM-5E-50-0100

Datenblatt Erstellungsdatum: 21.05.26 09:27

Überprüfen Sie das aktualisierte Dokument  [klicken](#)



TECHNISCHE DATEN

Mod.	PM-5E-50-0100
Durchmesser	50
Schutz	IP40
Gewicht (g)	490
Effizienz	0.62

Motor-Verbindungs-Kit, parallel, Mod. PM - Mod. PM

Produktcode: PM-5E-50-0100

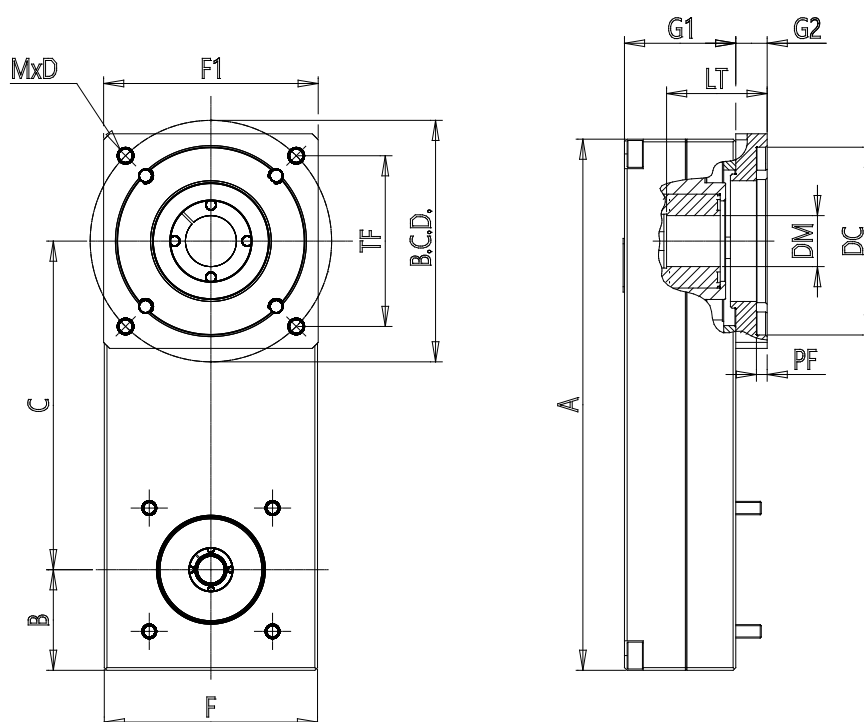

MAßE

DC (mm)	30.0
DM (mm)	8
LT (mm)	20.0
BCD (mm)	45
TF (mm)	0.0
MxD	M3x8
PF (mm)	6.0
F (mm)	49.5
F1 (mm)	0
A (mm)	122.5
B (mm)	24.8
C (mm)	72.5
G1 (mm)	37.0
G2 (mm)	0.0
J (kg*mm ²)	42.94