

Motor-Verbindungs-Kit, parallel, Mod. PM - Mod. PM

Produktcode: PM-5E-65-0024

Datenblatt Erstellungsdatum: 21.05.26 09:27

Überprüfen Sie das aktualisierte Dokument  [klicken](#)



TECHNISCHE DATEN

Mod.	PM-5E-65-0024
Durchmesser	65
Schutz	IP40
Gewicht (g)	1000
Effizienz	0.62

Motor-Verbindungs-Kit, parallel, Mod. PM - Mod. PM

Produktcode: PM-5E-65-0024

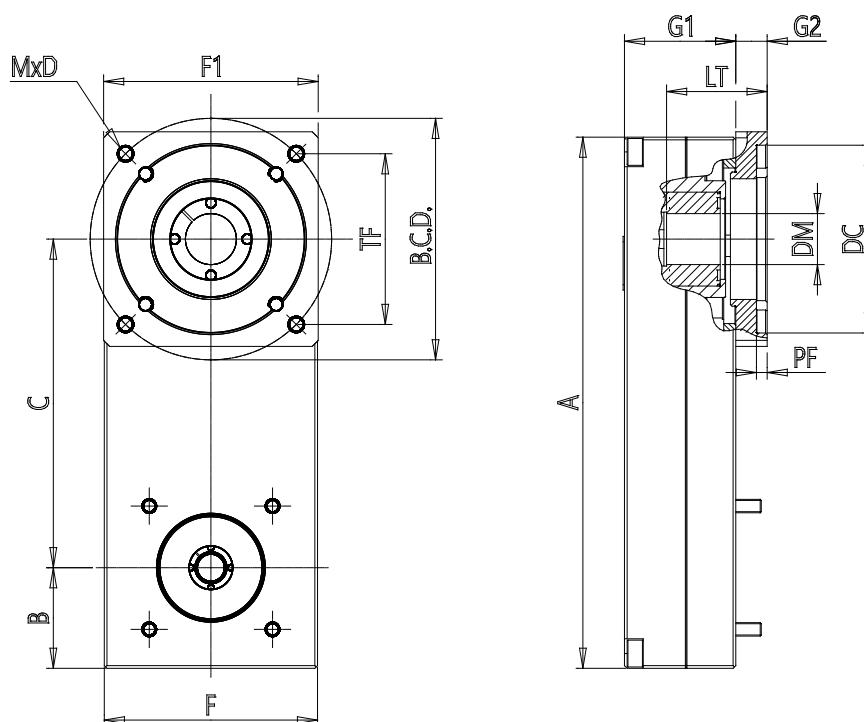

MAßE

DC (mm)	38.1
DM (mm)	8
LT (mm)	18.0
BCD (mm)	0
TF (mm)	47.1
MxD	M4x10
PF (mm)	5.0
F (mm)	64.5
F1 (mm)	0
A (mm)	164.5
B (mm)	32.0
C (mm)	94.5
G1 (mm)	42.0
G2 (mm)	0.0
J (kg*mm ²)	179.30