

Motor-Verbindungs-Kit, parallel, Mod. PM - Mod. PM

Produktcode: PM-5E-80-0400

Datenblatt Erstellungsdatum: 21.05.26 09:26

Überprüfen Sie das aktualisierte Dokument  [klicken](#)



TECHNISCHE DATEN

Mod.	PM-5E-80-0400
Durchmesser	80
Schutz	IP40
Gewicht (g)	1160
Effizienz	0.62

Motor-Verbindungs-Kit, parallel, Mod. PM - Mod. PM

Produktcode: PM-5E-80-0400

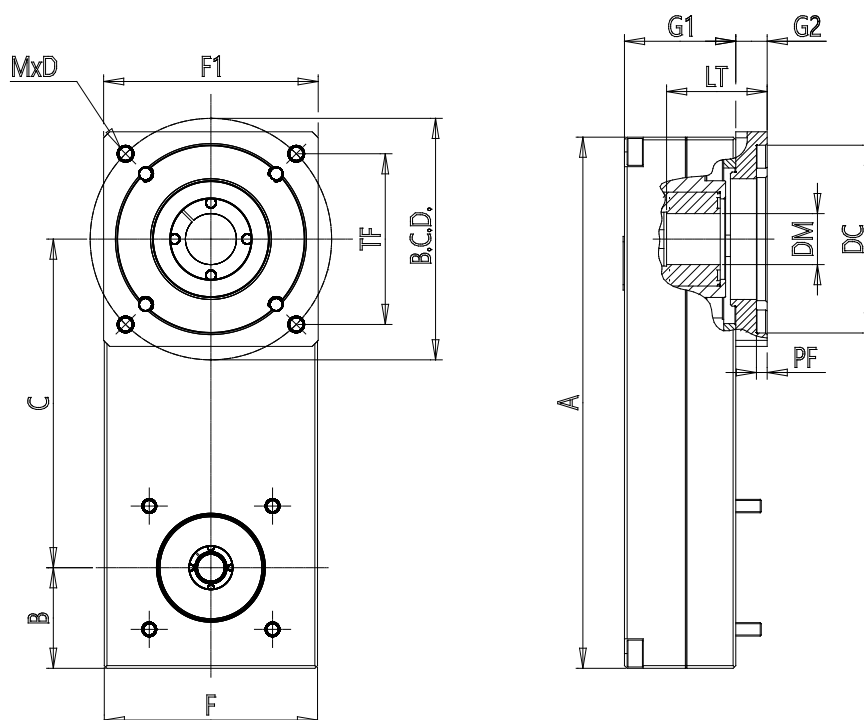

MAßE

DC (mm)	50.0
DM (mm)	14
LT (mm)	27.0
BCD (mm)	70
TF (mm)	0.0
MxD	M5x10
PF (mm)	4.0
F (mm)	79.5
F1 (mm)	0
A (mm)	198.0
B (mm)	37.5
C (mm)	120.0
G1 (mm)	41.5
G2 (mm)	0.0
J (kg*mm ²)	171.20