

Präzisionsdruckregler - Serie PR

Produktcode: PR204-M04

Datenblatt Erstellungsdatum: 21.05.26 01:55

Überprüfen Sie das aktualisierte Dokument  [klicken](#)



TECHNISCHE DATEN

Serie	PR
GRÖSSE	2
GEWINDEVERBINDUNGEN	04= G1/4
REGLERART	M = Manuell
BETRIEBSDRUCK	04= 0.05 ÷ 4bar

Präzisionsdruckregler - Serie PR

Produktcode: PR204-M04

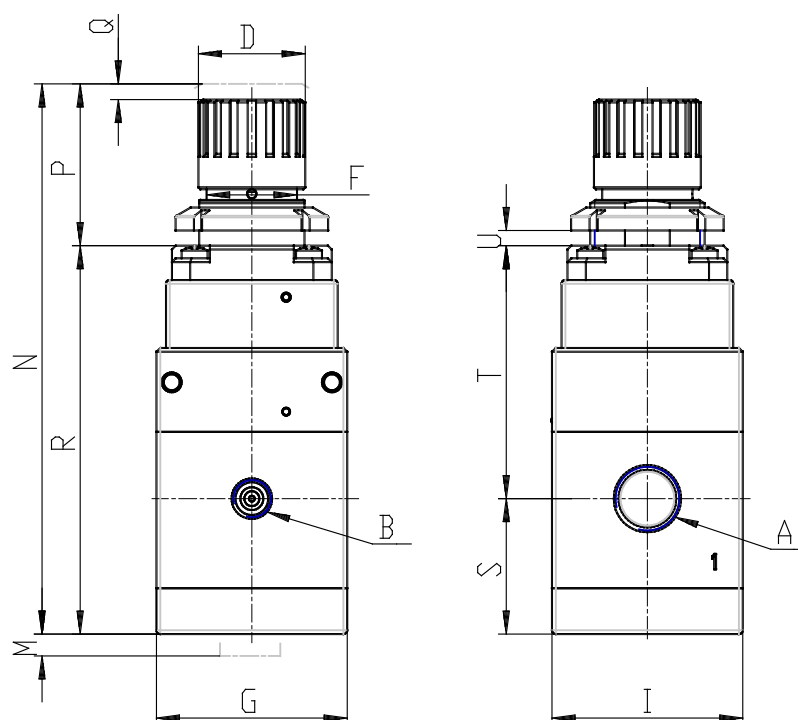

MAßE

A	G1/4
Gewindelaenge	G1/8
D (mm)	28
F (mm)	30
G (mm)	50
I (mm)	50
M (mm)	25
N (mm)	141.8
P (mm)	40
Q (mm)	2
R (mm)	101.8
schwer (mm)	35.5
T (mm)	0.0
U	0 - 6
Gewicht (kg)	0.645