

Führungseinheiten - Serie QCT QCB

Produktcode: QCB2A020A015

Datenblatt Erstellungsdatum: 20.05.26 17:42

Überprüfen Sie das aktualisierte Dokument  [klicken](#)



TECHNISCHE DATEN

SERIE (Serie)	QC
VERSION (Version)	B = Kugelumlaufbuchsen
FUNZ (Funktion)	2 = doppelwirkend
MAT (Werkstoff)	A= Körper Aluminium eloxiert, Kolbenstange Edelstahl gerollt 1.4305, Führungsstangen Stahl gehärtet C50 für QCB
PHY (Diameter / mm)	20
TYP (Bauart)	A = Standard
HUB (Hub / mm)	15
ATEX (Zertifizierungen)	= standard

Führungseinheiten - Serie QCT QCB

Produktcode: QCB2A020A015

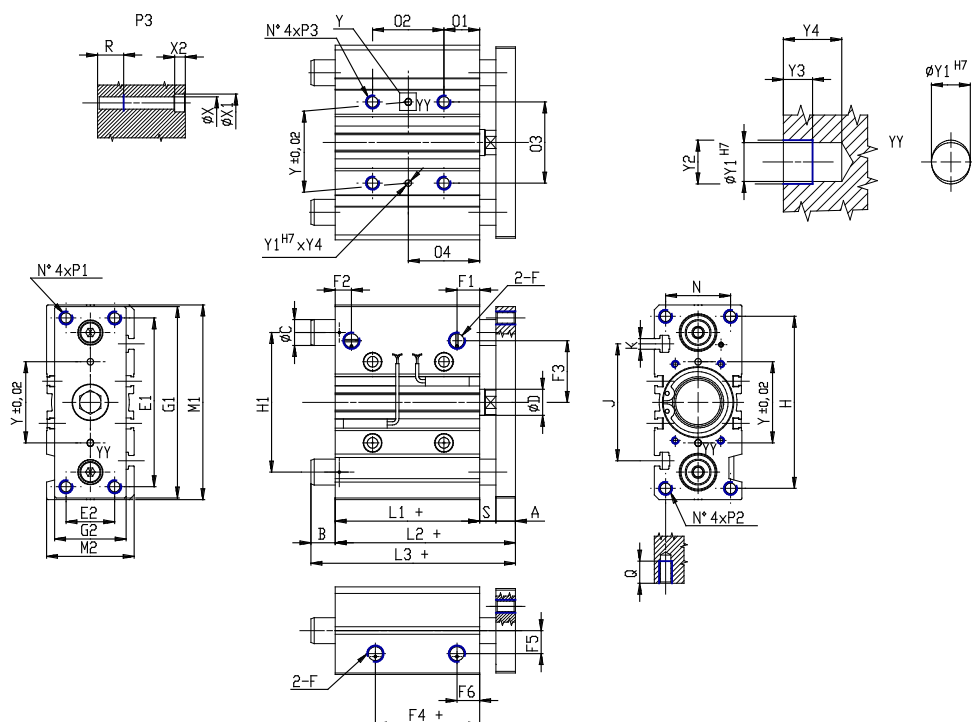

MAßE

L3 (mm)	72.0
C (mm)	10
B (mm)	19.0
O2 (mm)	24
O4 (mm)	29
A (mm)	10
D (mm)	10
E1 (mm)	70
E2 (mm)	18
F	G 1/8
F1 (mm)	10.5
F2 (mm)	10.5
F3 (mm)	25.0
F4 (mm)	12.5
F5 (mm)	11.5
F6 (mm)	10.5
G1 (mm)	81
G2 (mm)	30
H (mm)	72
H1 (mm)	54
L1 (mm)	37.0
L2 (mm)	53.0
M1 (mm)	83

M2 (mm)	36
N (mm)	24
O1 (mm)	17
O3 (mm)	28
P1	M5x0.8
P2	M5x0.8
P3	M6x1
Q (mm)	13
R (mm)	12
schwer (mm)	6
Y (mm)	28
Y1 (mm)	3
Y2 (mm)	3.5
Y3 (mm)	3
Y4 (mm)	6
X (mm)	5.5
X1 (mm)	9
X2 (mm)	5.0
J (mm)	44
K	M5