

Kurzhubzylinder - Serie QL

Produktcode: QLM2A012A030

Datenblatt Erstellungsdatum: 21.05.26 00:05

Überprüfen Sie das aktualisierte Dokument  [klicken](#)



TECHNISCHE DATEN

Serie	QL
Version	M = Magnetisch
Funktion	2 = doppeltwirkend
Werkstoffe	A = Kolbenstange Edelstahl gerollt - AL-Profil
Bauart	A = Standard
Diameter (mm)	Ø12
Hub (mm)	30
Stangenoptionen	= Standard
Zertifizierungen	= Standard

Kurzhubzylinder - Serie QL

Produktcode: QLM2A012A030

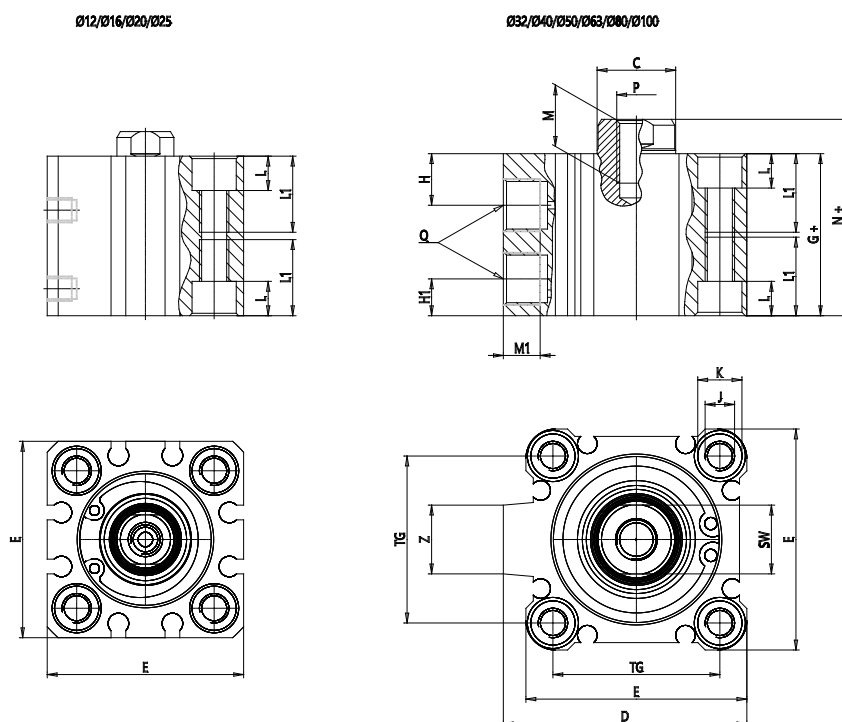

MAßE

C (mm)	6
D (mm)	0.0
E (mm)	25.0
G (mm)	28.0
H (mm)	7.5
H1 (mm)	5.0
J	M4x0.7
K (mm)	6.5
L (mm)	3.5
L1 (mm)	11.0
M (mm)	6
M1 (mm)	6.0
N (mm)	31.5
P	M3x0.5
Q	M5x0.8
SW (mm)	5
TG (mm)	15.5
Z (mm)	0
W (mm)	14.0
KK	M5x0.8
AM (mm)	10.5