

Kurzhubzylinder - Serie QP-QPR

Produktcode: QP1A016A005

Datenblatt Erstellungsdatum: 20.05.26 17:16

Überprüfen Sie das aktualisierte Dokument  [klicken](#)



TECHNISCHE DATEN

Serie	QP = standard
Funktion	1 = einfachwirkend
Werkstoff	A = Edelstahl gerollt
Diameter (mm)	16
Bauart	A = Standard
Hub (mm)	5
Dichtungsoptionen	-
Zertifizierungen	= standard

Kurzhubzylinder - Serie QP-QPR

Produktcode: QP1A016A005

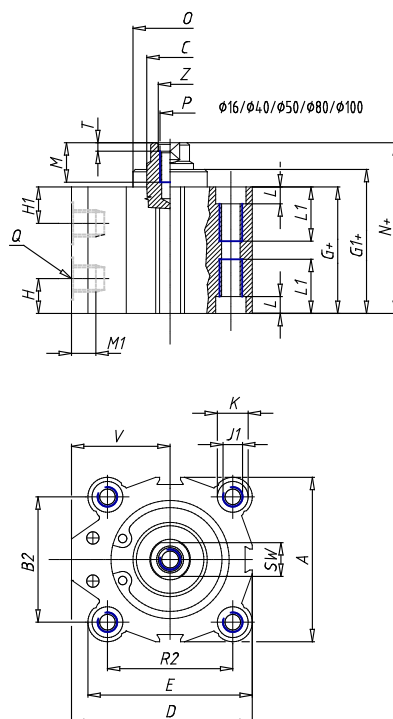

MAßE

A (mm)	29.0
B (mm)	20.0
B1 (mm)	-
B2 (mm)	-
Ø C (mm)	8
D (mm)	29.00
E (mm)	29.00
G (mm)	37.0
G1 (mm)	37.4
H1 (mm)	10.9
H (mm)	8.7
J (mm)	3.5
J1	-
K (mm)	5.8
L (mm)	3.0
L1 (mm)	-
M (mm)	8.0
M1 (mm)	4.5
N (mm)	41.4
N1 (mm)	-
Ø O (mm)	16.6
P	M4
Q	M5

R (mm)	20.0
R1 (mm)	-
R2 (mm)	-
SW (mm)	6
t (mm)	-
U (mm)	-
V (mm)	14.50
AA (mm)	5
BB (mm)	3.5
Ø CC (mm)	6.2
Ø DD (mm)	3.2
EE (mm)	6.5
FF	M3
LL (mm)	20.0
MM (mm)	28.0
NN (mm)	28
RR (mm)	20.0
VV (mm)	-
Z (mm)	-