

Mod. S2530 - Verschraubungen Sprint Serie S2000

Produktcode: S2530 1/2-1/8

Datenblatt Erstellungsdatum: 21.05.26 02:02

Überprüfen Sie das aktualisierte Dokument  [klicken](#)



TECHNISCHE DATEN

Mod.	S2530 1/2-1/8
------	---------------

Mod. S2530 - Verschraubungen Sprint Serie S2000

Produktcode: S2530 1/2-1/8

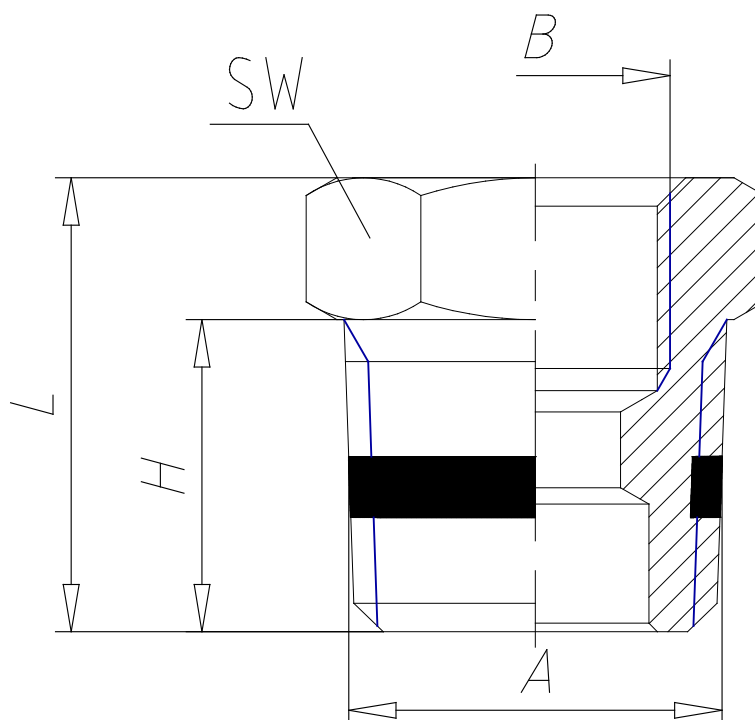

MAßE

A	R1/2
B	G1/8
H (mm)	14.0
L (mm)	19.5
SW (mm)	22