

Mod. S2530 - Verschraubungen Sprint Serie S2000

Produktcode: S2530 3/8-1/8

Datenblatt Erstellungsdatum: 21.05.26 02:03

Überprüfen Sie das aktualisierte Dokument  [klicken](#)



TECHNISCHE DATEN

Mod.	S2530 3/8-1/8
------	---------------

Mod. S2530 - Verschraubungen Sprint Serie S2000

Produktcode: S2530 3/8-1/8

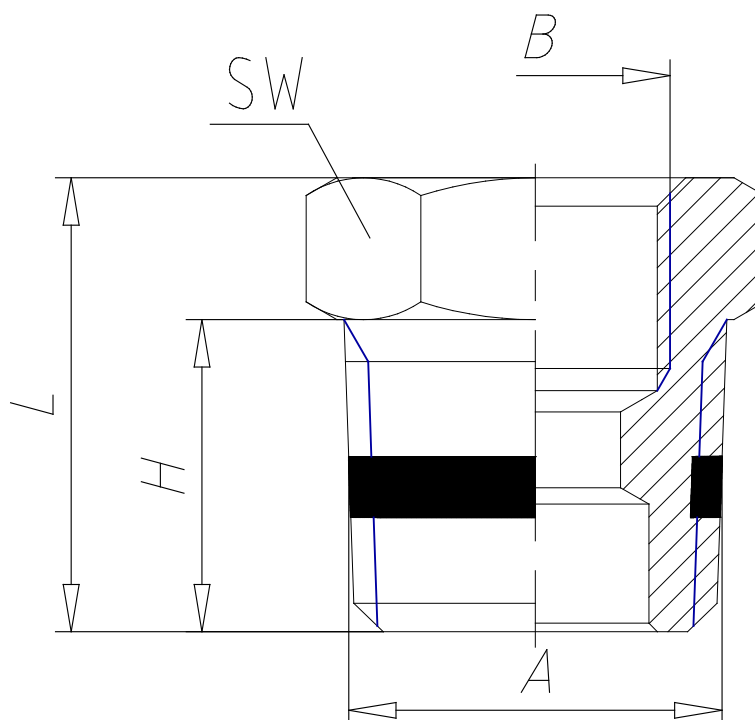

MAßE

A	R3/8
B	G1/8
H (mm)	11.5
L (mm)	16.5
SW (mm)	17