

Microregler - Serie T

Produktcode: T104-R11

Datenblatt Erstellungsdatum: 21.05.26 01:25

Überprüfen Sie das aktualisierte Dokument [klicken](#)



TECHNISCHE DATEN

Mod.	T104-R11
U	G1/4

Microregler - Serie T

Produktcode: T104-R11

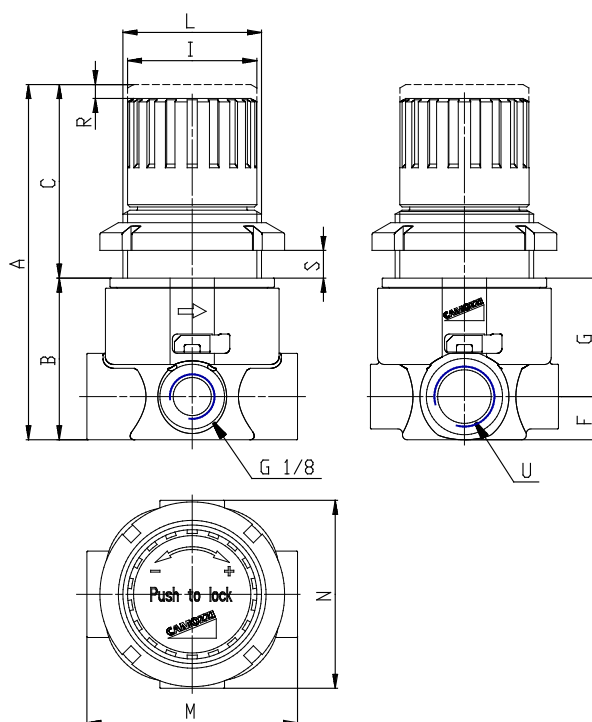

MAßE

A (mm)	77
B (mm)	35
C (mm)	42
F (mm)	9.5
G (mm)	25.5
I (mm)	28
leicht	M30x1.5
M (mm)	46
N (mm)	41
R (mm)	3