

Microregler - Serie T

Produktcode: T104-R70

Datenblatt Erstellungsdatum: 20.05.26 16:50

Überprüfen Sie das aktualisierte Dokument [klicken](#)



TECHNISCHE DATEN

Mod.	T104-R70
U	G1/4

Microregler - Serie T

Produktcode: T104-R70

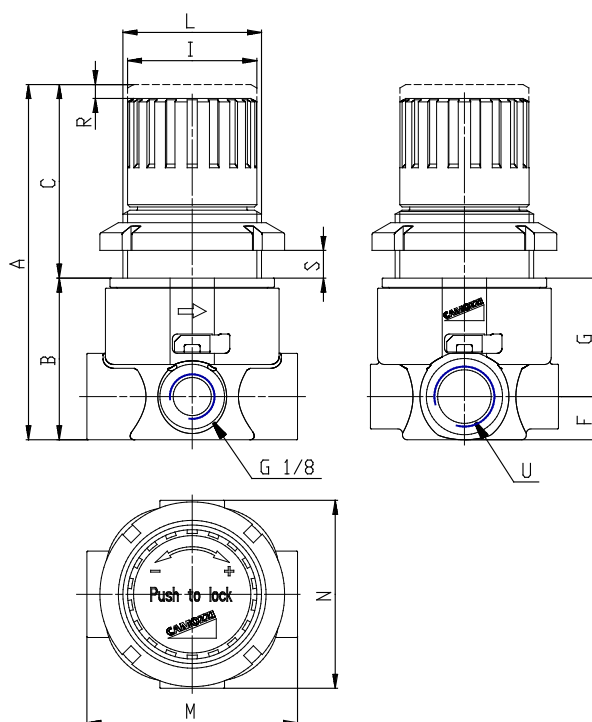

MAßE

A (mm)	77
B (mm)	35
C (mm)	42
F (mm)	9.5
G (mm)	25.5
I (mm)	28
leicht	M30x1.5
M (mm)	46
N (mm)	41
R (mm)	3