

Mutter - Mod. V-97

Produktcode: V-97-40

Datenblatt Erstellungsdatum: 21.05.26 09:50

Überprüfen Sie das aktualisierte Dokument  [klicken](#)



TECHNISCHE DATEN

Mod.	V-97-40
------	---------

Mutter - Mod. V-97

Produktcode: V-97-40

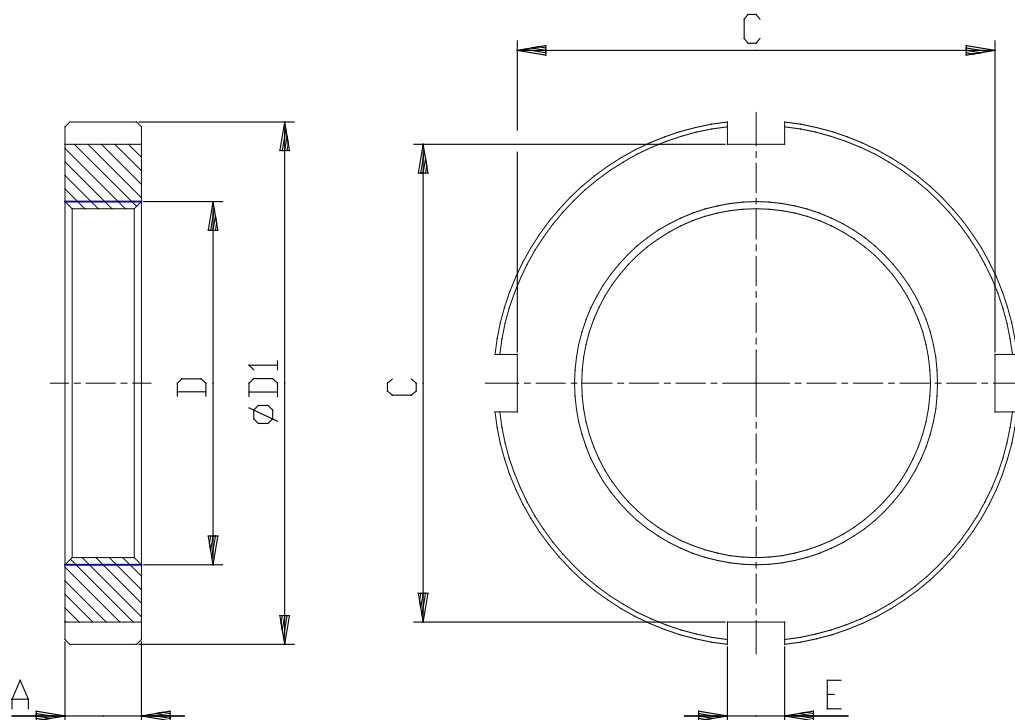

MAßE

A (mm)	8
D	M38X1,5
D1 (mm)	55
E (mm)	6
C (mm)	50