

Stopventil - Mod. VBO

Produktcode: VBO 1/8

Datenblatt Erstellungsdatum: 20.05.26 16:49

Überprüfen Sie das aktualisierte Dokument [klicken](#)



TECHNISCHE DATEN

Mod.	VBO 1/8
------	---------

Stopventil - Mod. VBO

Produktcode: VBO 1/8

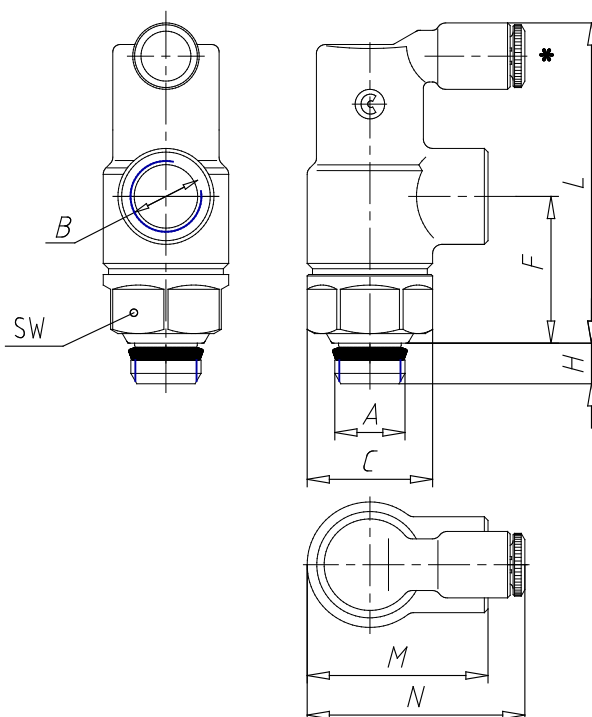

MAßE

A	1/8
B	1/8
C (mm)	16.9
F (mm)	20.0
H (mm)	5.5
leicht (mm)	43.0
M (mm)	24.5
N (mm)	30.0
SW (mm)	15