

Stopventil - Mod. VBO

Produktcode: VBO 3/8

Datenblatt Erstellungsdatum: 21.05.26 01:09

Überprüfen Sie das aktualisierte Dokument  [klicken](#)



TECHNISCHE DATEN

Mod.	VBO 3/8
------	---------

Stopventil - Mod. VBO

Produktcode: VBO 3/8

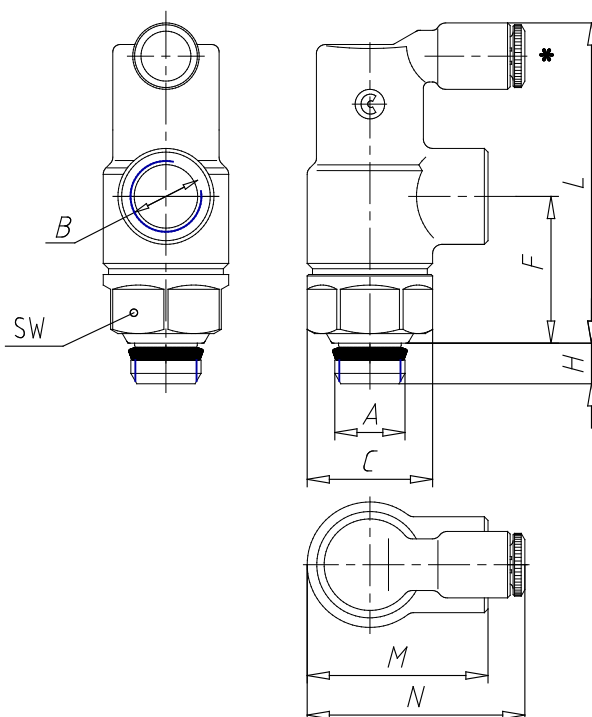

MAßE

A	3/8
B	3/8
C (mm)	26.8
F (mm)	33.0
H (mm)	8.0
leicht (mm)	67.0
M (mm)	40.0
N (mm)	39.5
SW (mm)	24