

Inlinerejektoren - Serie VED

Produktcode: VED-07

Datenblatt Erstellungsdatum: 21.05.26 00:19

Überprüfen Sie das aktualisierte Dokument [klicken](#)



TECHNISCHE DATEN

Mod.	VED-07
------	--------

Inlinerejektoren - Serie VED

Produktcode: VED-07

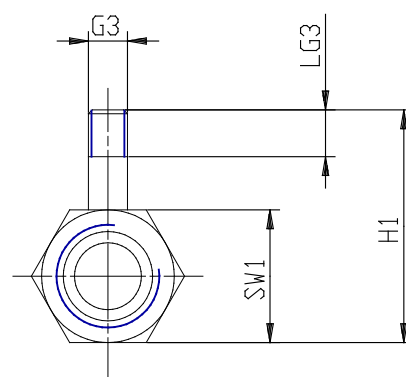
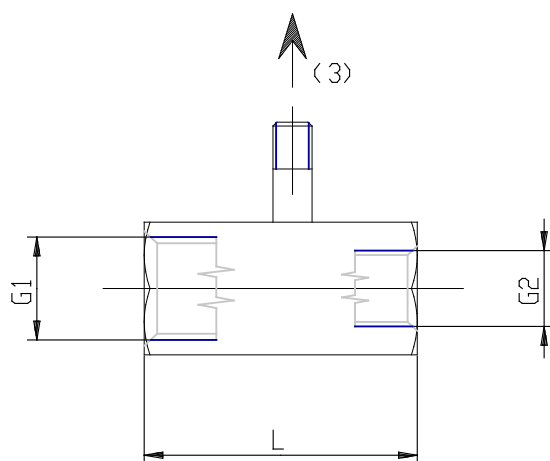
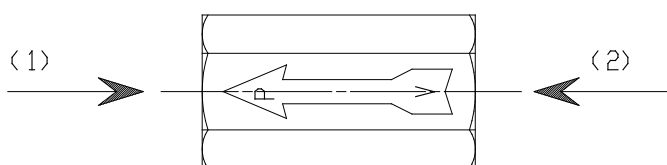

MAßE

G1	G1/4
G2	G1/8
G3	M5
H1 (mm)	29.8
L (mm)	35
LG3 (mm)	5
SW1 (mm)	17