

Flachsauggreifer (oval) - Serie VTOF

Produktcode: VTOF-0750-250N-1/4F

Datenblatt Erstellungsdatum: 21.05.26 11:52

Überprüfen Sie das aktualisierte Dokument  [klicken](#)



TECHNISCHE DATEN

Serie	VTOF
Werkstoffe	N = NBR
Gewindegröße	G1/4
Gewindetyp	F = Innengewinde

Flachsauggreifer (oval) - Serie VTOF

Produktcode: VTOF-0750-250N-1/4F

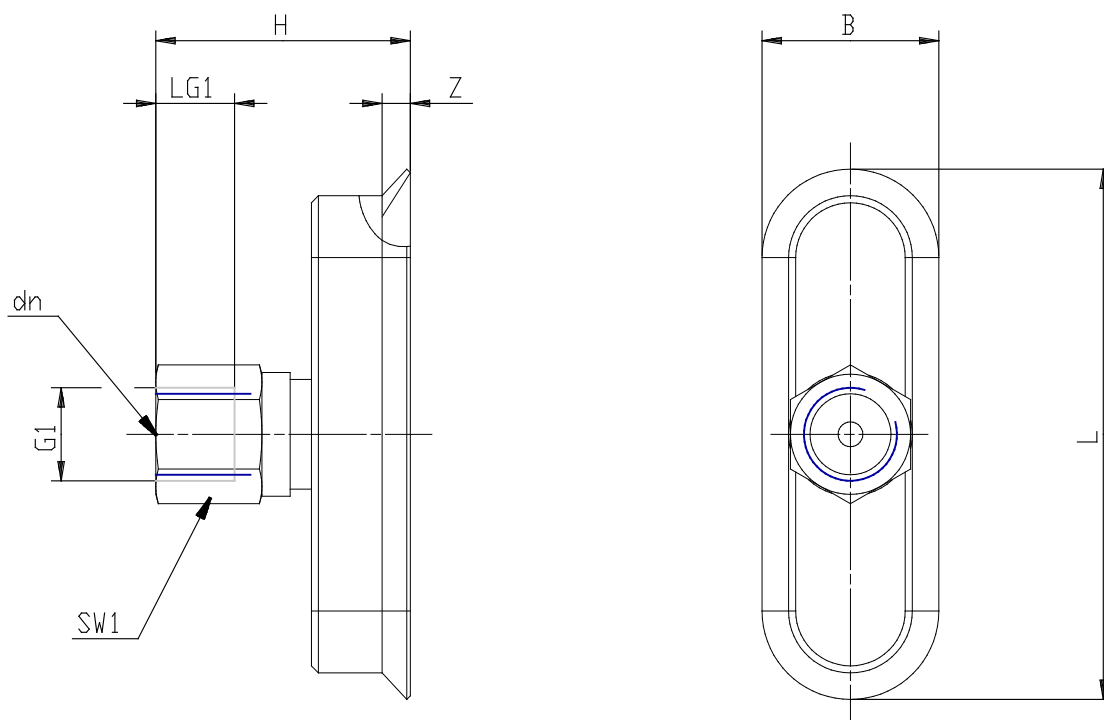

MAßE

DN (mm)	3.5
G1	G1/4F
H (mm)	36
L (mm)	75
LG1 (mm)	12.0
SW1 (mm)	17
Z (mm)	2.8
Sauggreifer	VTOF-0750-250*
Anschlussnippel	NPV-Q-1/4-F