

Connectors (G90) - Mod. 122

Product code: 122-550-5

Datasheet creation date: 07/03/2025 16:11

Check the most updated document online [click here](#)



TECHNICAL DATA

Mod.	122-550-5
Description	moulded cable, without electronics
Colour	Black
Working	-
Cable length [L] (mm)	5000
Cable holding	-
Tightening torque (N)	0.5 Nm

Connectors (G90) - Mod. 122

Product code: 122-550-5

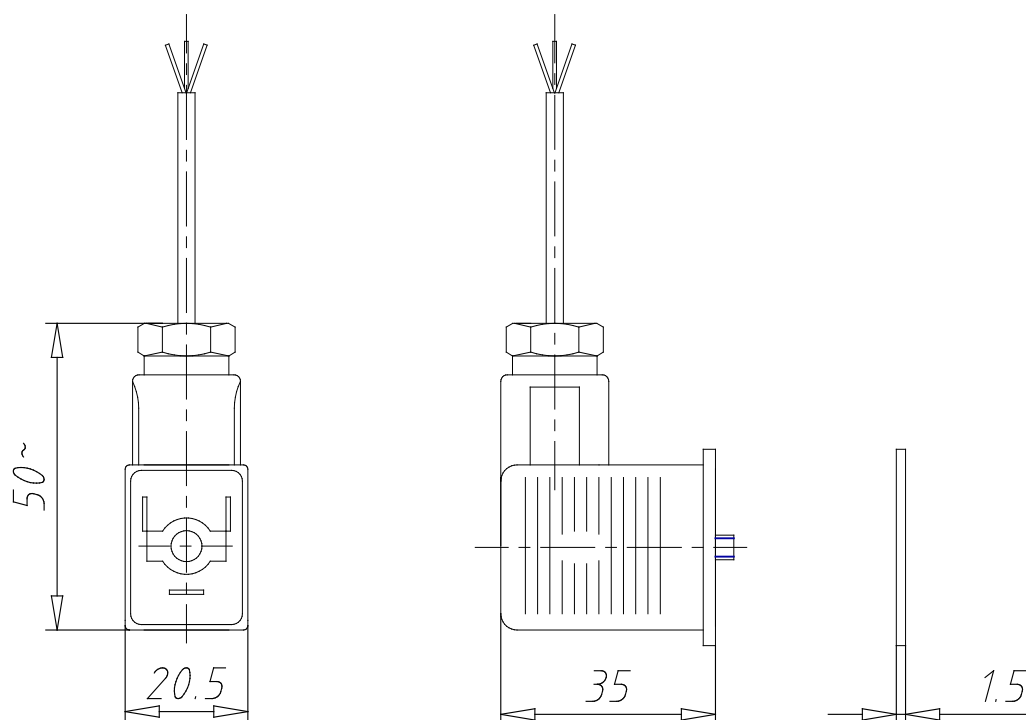

DIMENSIONS

Mod.	122-550-5
Description	moulded cable, without electronics
Colour	Black
Working	-
Cable length [L] (mm)	5000
Cable holding	-
Tightening torque (N)	0.5 Nm