

Connectors - Mod. 122-...

Product code: 122-702

Datasheet creation date: 07/03/2025 16:11

Check the most updated document online [click here](#)



TECHNICAL DATA

Mod.	122-702
Description	Connector, varistor + LED
Colour	transparent
Working voltage	110 V AC/DC
Cable holding	PG9
Tightening torque (N*m)	0.5

Connectors - Mod. 122-...

Product code: 122-702

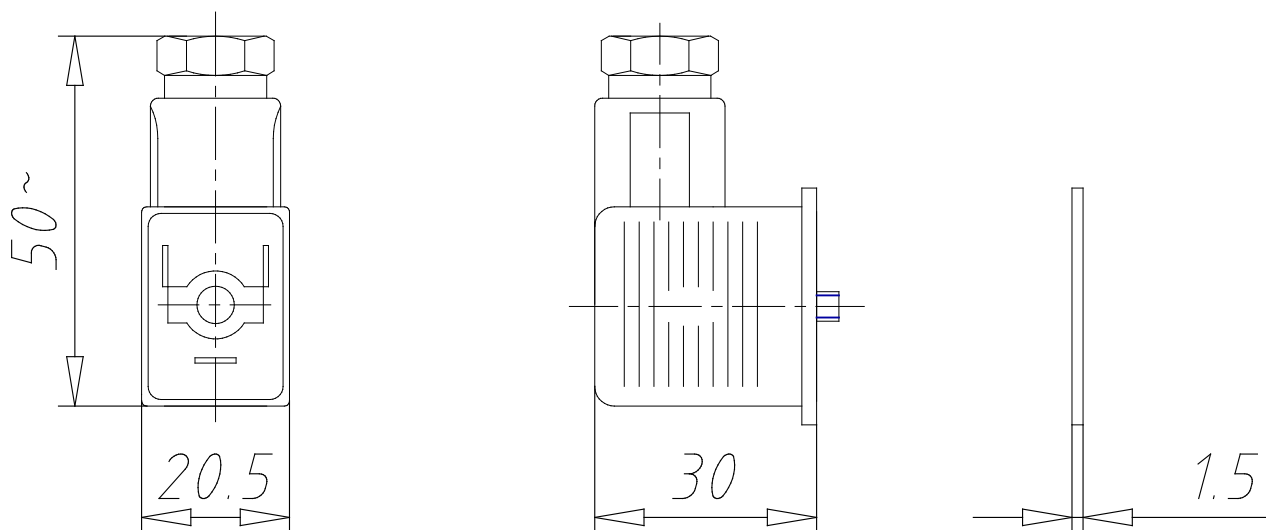

DIMENSIONS

Mod.	122-702
Description	Connector, varistor + LED
Colour	transparent
Working voltage	110 V AC/DC
Cable holding	PG9
Tightening torque (N*m)	0.5