

- Fittings Mod. 1230

Product code: 1230 6

Datasheet creation date: 10/03/2025 10:33

Check the most updated document online [click here](#)



■ TECHNICAL DATA

Mod.	1230 6
------	--------

- Fittings Mod. 1230

Product code: 1230 6

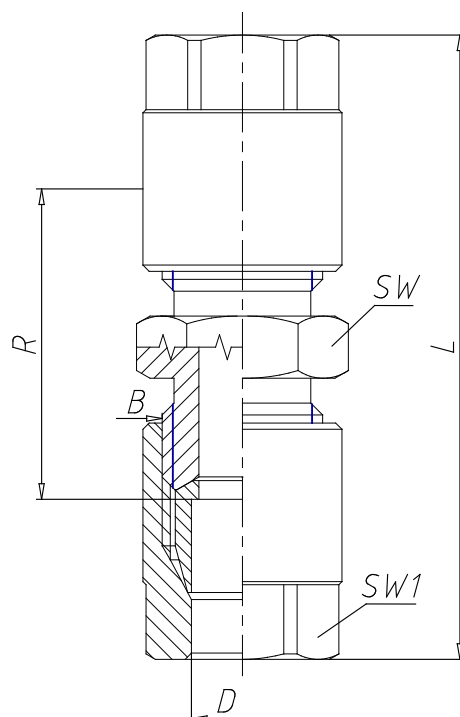

■ DIMENSIONS

D (mm)	6
B	1/8
L (mm)	42.5
R (mm)	21.5
SW (mm)	12
SW1 (mm)	12
With bi-conical olive	-