

- Fittings Mod. 1230

Product code: 1230 8

Datasheet creation date: 10/03/2025 10:33

Check the most updated document online [click here](#)



■ TECHNICAL DATA

Mod.	1230 8
------	--------

- Fittings Mod. 1230

Product code: 1230 8

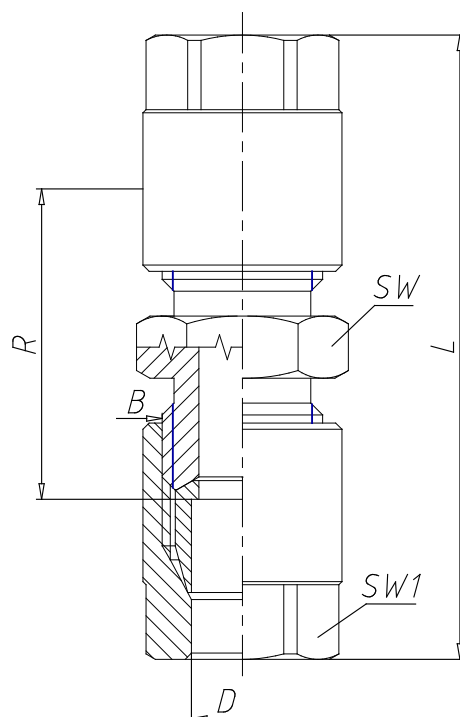

■ DIMENSIONS

D (mm)	8
B	1/4
L (mm)	51.0
R (mm)	25.0
SW (mm)	14
SW1 (mm)	14
With bi-conical olive	-