

Connectors (A80) - Mod. 124

Product code: 124-701

Datasheet creation date: 07/03/2025 16:10

Check the most updated document online [click here](#)



TECHNICAL DATA

Mod.	124-701
Description	Connector, varistor + Led
Colour	Black
Working (V)	24V AC/DC
Cable holding	PG9/PG11
Tightening torque	0.5Nm

Connectors (A80) - Mod. 124

Product code: 124-701

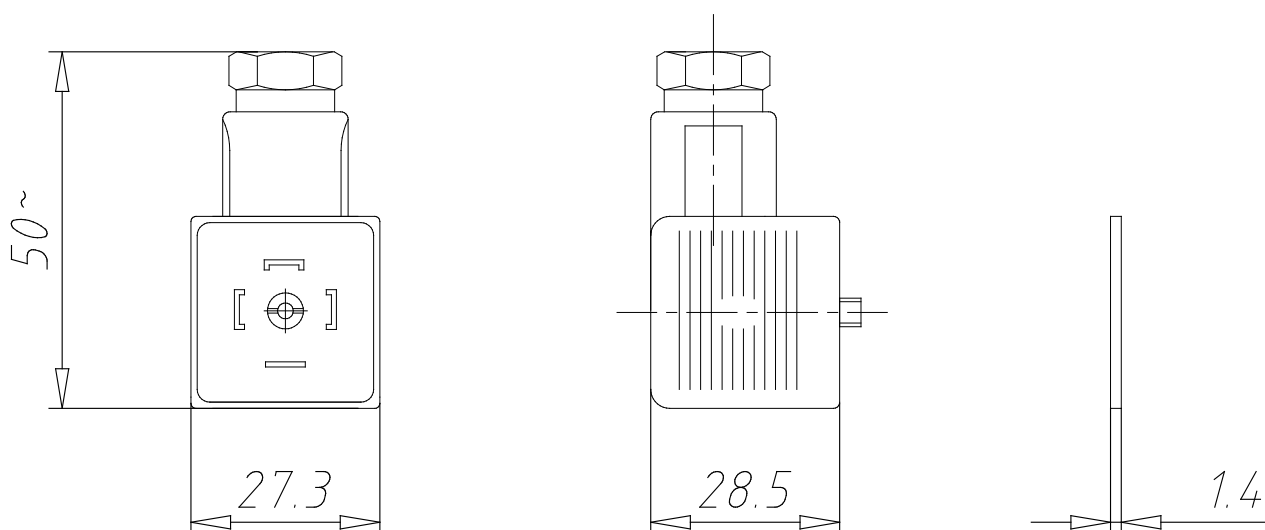

DIMENSIONS

Mod.	124-701
Description	Connector, varistor + Led
Colour	Black
Working (V)	24V AC/DC
Cable holding	PG9/PG11
Tightening torque	0.5Nm