

Electronic control device for proportional valves - Series 130

Product code: 130-242

Datasheet creation date: 10/03/2025 10:54

Check the most updated document online [click here](#)



TECHNICAL DATA

Series	130
Voltage	2= 24V DC (Pmax 24W)
Power	4= 4.3W
Frequency	2= 500Hz

Electronic control device for proportional valves - Series 130

Product code: 130-242

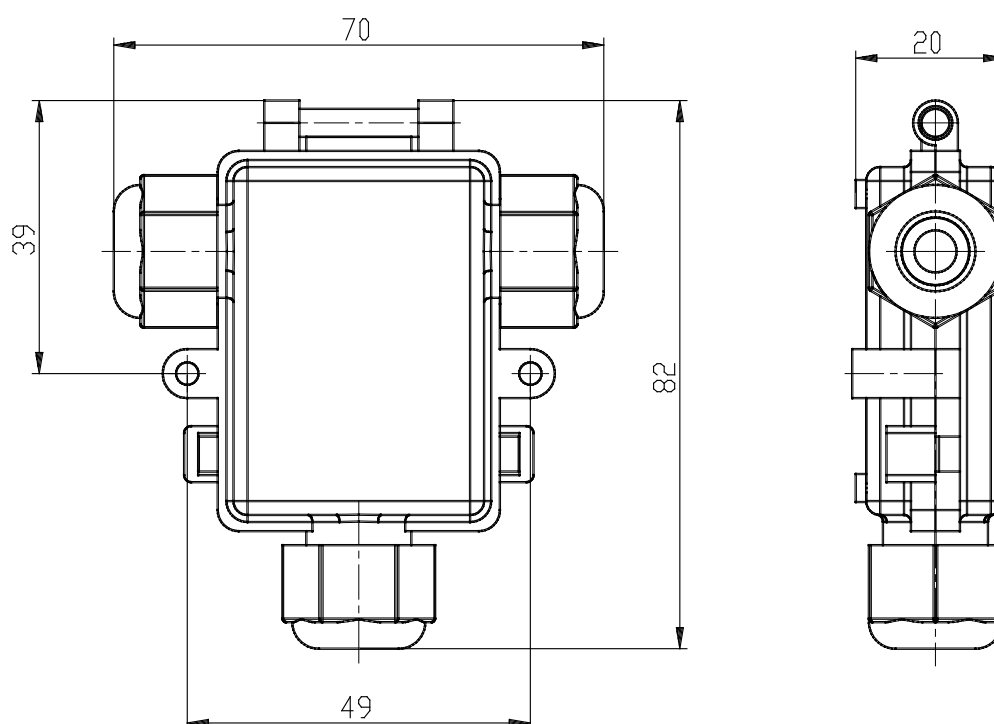

DIMENSIONS

Series	130
Voltage	2= 24V DC (Pmax 24W)
Power	4= 4.3W
Frequency	2= 500Hz