

Electronic control device for proportional valves - Series 130

Product code: 130-313

Datasheet creation date: 10/03/2025 10:54

Check the most updated document online [click here](#)



TECHNICAL DATA

Series	130
Voltage	3= 12V DC (Pmax 12W)
Power	1= 3W
Frequency	3= 1KHz

Electronic control device for proportional valves - Series 130

Product code: 130-313

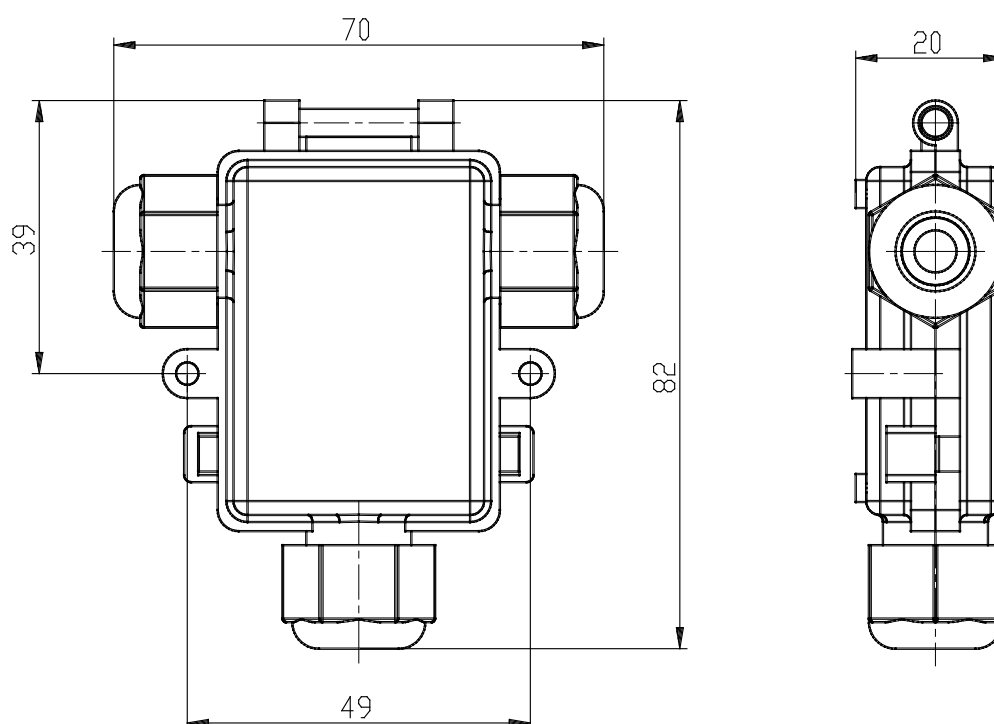

DIMENSIONS

Series	130
Voltage	3= 12V DC (Pmax 12W)
Power	1= 3W
Frequency	3= 1KHz