

Electronic control device for proportional valves - Series 130

Product code: 130-433

Datasheet creation date: 10/03/2025 10:54

Check the most updated document online [click here](#)



TECHNICAL DATA

Series	130
Voltage	4= 6V DC (Pmax 6W)
Power	3= 3.2W
Frequency	3= 1KHz

Electronic control device for proportional valves - Series 130

Product code: 130-433

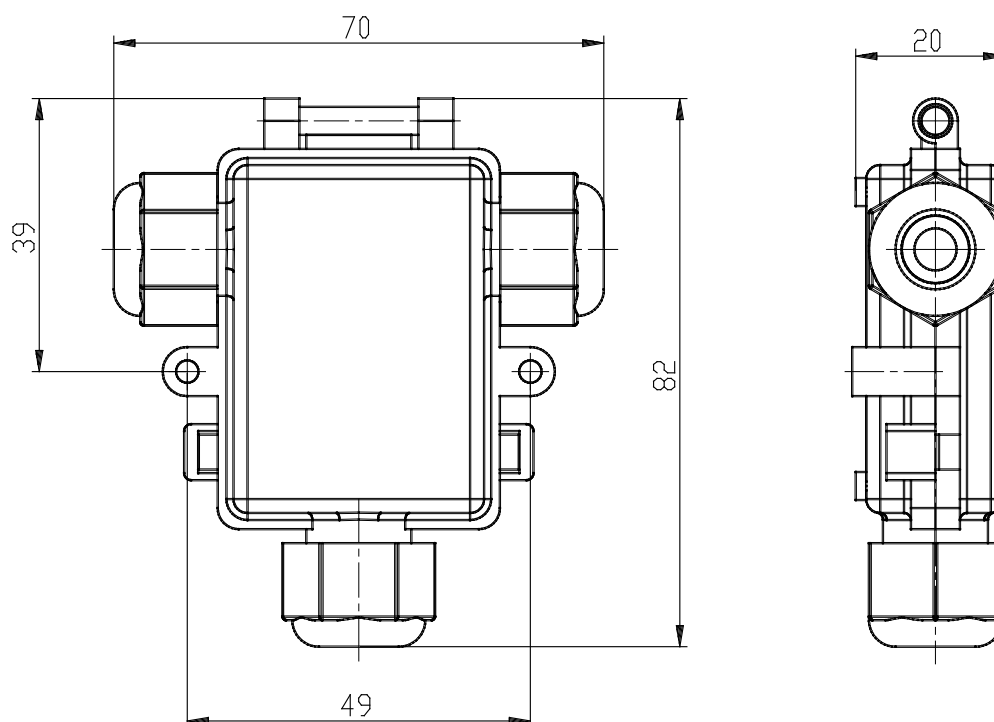

DIMENSIONS

Series	130
Voltage	4= 6V DC (Pmax 6W)
Power	3= 3.2W
Frequency	3= 1KHz