

Mechanically operated valves - Series 1 and 3 / 158-955

Product code: 158-955

Datasheet creation date: 10/03/2025 12:06

Check the most updated document online [click here](#)



TECHNICAL DATA

Mod.	158-955
Operating pressure (bar)	0÷10 bar
Flow rate	500NL/min
Actuating force	92N
Activity	Actuating lever / roller

Mechanically operated valves - Series 1 and 3 / 158-955

Product code: 158-955

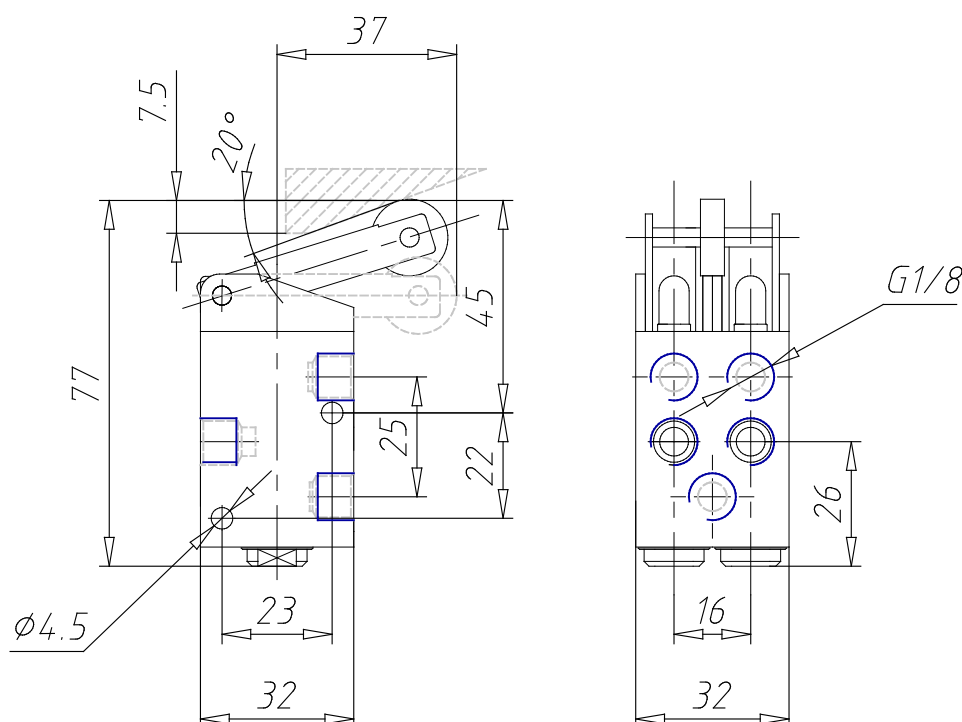

DIMENSIONS

Mod.	158-955
Operating pressure (bar)	0÷10 bar
Flow rate	500NL/min
Actuating force	92N
Activity	Actuating lever / roller