

Mechanically operated minivalves - Series 2 / 234-945

Product code: 235-945

Datasheet creation date: 10/03/2025 12:06

Check the most updated document online [click here](#)



TECHNICAL DATA

Mod.	235-945
Operating pressure (bar)	2 ÷ 10
Flow rate	60NL/min
Actuating force	a 6 bar =6N
Activity	Actuating plunger

Mechanically operated minivalves - Series 2 / 234-945

Product code: 235-945

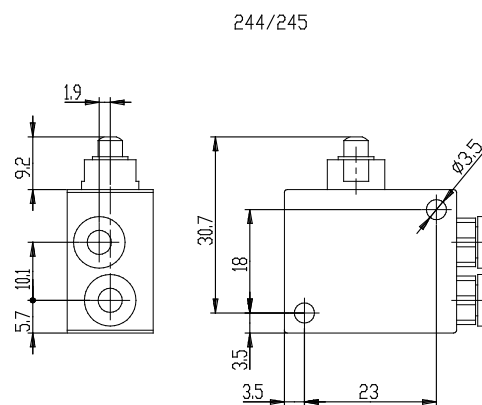
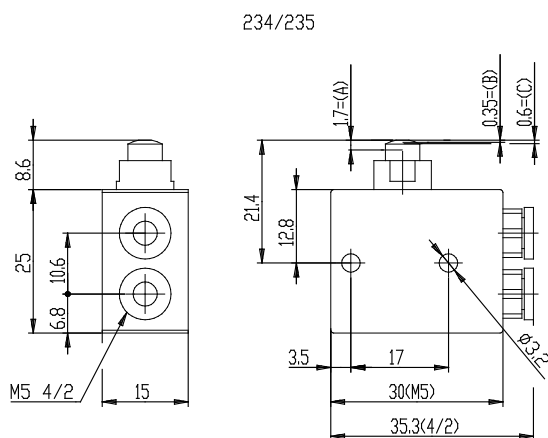

DIMENSIONS

Mod.	235-945
Operating pressure (bar)	2 ÷ 10
Flow rate	60NL/min
Actuating force	a 6 bar =6N
Activity	Actuating plunger