

Mechanically operated minivalves - Series 2 / 234-965

Product code: 244-965

Datasheet creation date: 10/03/2025 12:07

Check the most updated document online [click here](#)



TECHNICAL DATA

Mod.	244-965
Operating pressure (bar)	2 ÷ 10
Flow rate NI/min	60NL/min
Actuating force	a 6 bar =6N
Thread port (mm)	Ø4
Activity	Actuating unidirectional lever / roller

Mechanically operated minivalves - Series 2 / 234-965

Product code: 244-965

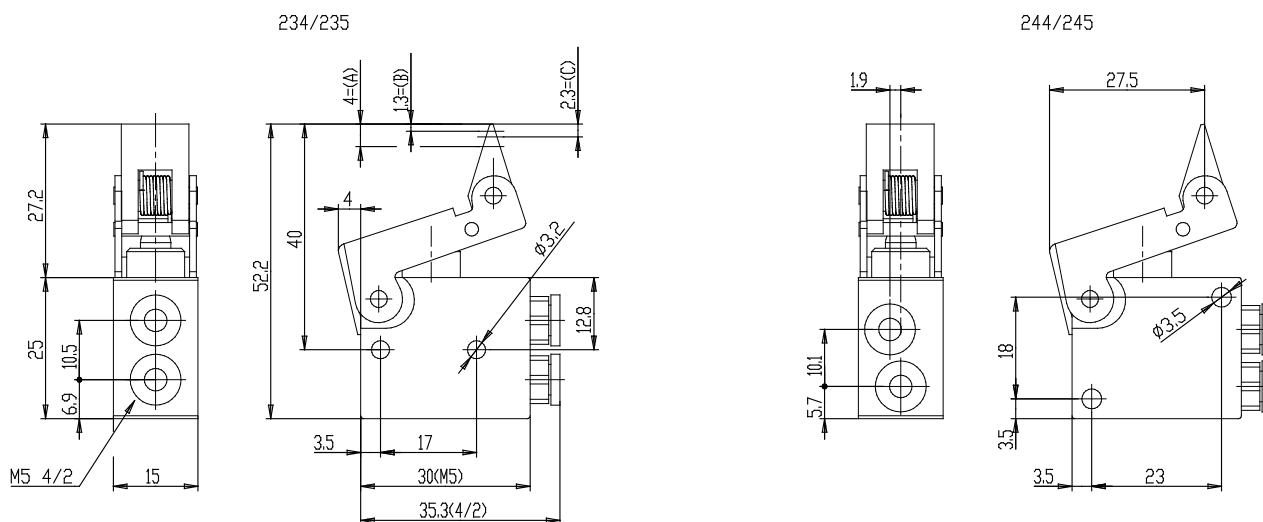

DIMENSIONS

Mod.	244-965
Operating pressure (bar)	2 ÷ 10
Flow rate NI/min	60NL/min
Actuating force	a 6 bar =6N
Thread port (mm)	Ø4
Activity	Actuating unidirectional lever / roller