

## Minicylinders - Series 16 - 23 - 24 - 25

Product code: 24N2A20RL100

Datasheet creation date: 07/03/2025 18:17

Check the most updated document online [click here](#)



### TECHNICAL DATA

<b>Series (mm)</b>	24
<b>Bore (mm)</b>	20
<b>Version</b>	N = standard
<b>Operation</b>	2 = double acting
<b>Materials</b>	A = rolled stainless steel stem - stainless steel jacket
<b>Construction</b>	RL = cylinder with rod lock
<b>Stroke type</b>	standard
<b>Stroke (mm)</b>	100
<b>Rod seals material</b>	= standard
<b>Extended rod (mm)</b>	0

## Minicylinders - Series 16 - 23 - 24 - 25

Product code: 24N2A20RL100

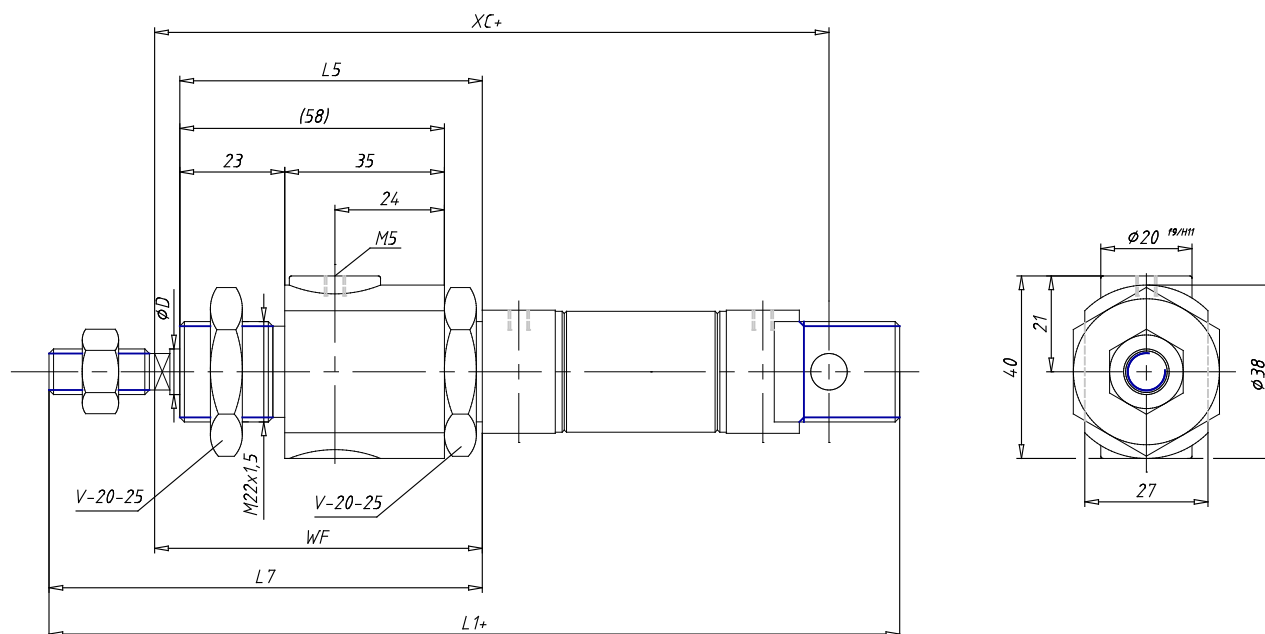

### DIMENSIONS

EW (mm)	16
KW (mm)	10
BE	M22x1,5
KK	M8x1,25
$\phi CD$ (mm)	8
D1 (mm)	22.0
EE	G1/8
$\phi D2$ (mm)	8
L1 (mm)	282.0
XC (mm)	245
L2 (mm)	168.0
AM (mm)	20
L3 (mm)	18
L4 (mm)	8.0
L5 (mm)	70
L (mm)	12
WF (mm)	74
L6 (mm)	16
L7 (mm)	94
KV (mm)	32
SW (mm)	7
D (mm)	27.0
D3 (mm)	27