

Mod. 2500 - Fittings Serie 2000

Product code: 2500 3/4

Datasheet creation date: 10/03/2025 02:48

Check the most updated document online [click here](#)



■ TECHNICAL DATA

Mod.	2500 3/4
------	----------

Mod. 2500 - Fittings Serie 2000

Product code: 2500 3/4

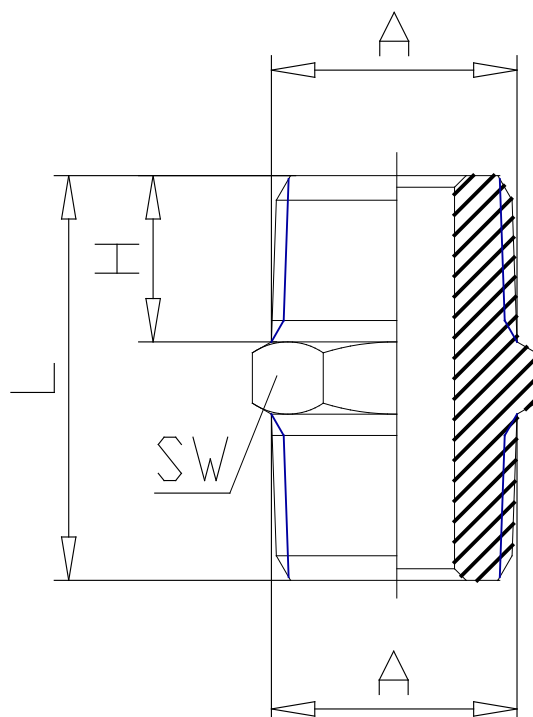

DIMENSIONS

A	R3/4
H (mm)	16.5
L (mm)	40.0
SW (mm)	27