

Mod. 2521 - Fittings Serie 2000

Product code: 2521 3/8-1/2

Datasheet creation date: 10/03/2025 02:50

Check the most updated document online [click here](#)



■ TECHNICAL DATA

Mod.	2521 3/8-1/2
------	--------------

Mod. 2521 - Fittings Serie 2000

Product code: 2521 3/8-1/2

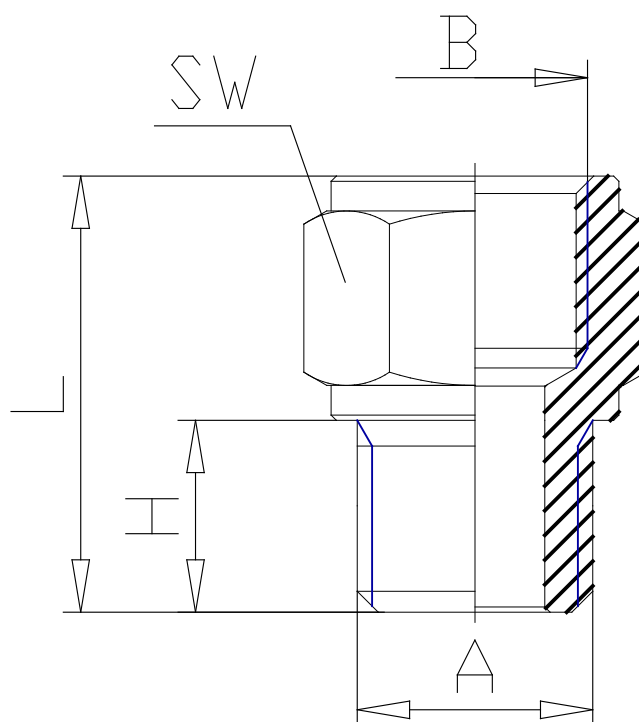

DIMENSIONS

A	G3/8
B	G1/2
H (mm)	9
L (mm)	25.5
SW (mm)	24