

Minicylinders - Series 16 - 23 - 24 - 25

Product code: 25N2A20RL200

Datasheet creation date: 07/03/2025 18:41

Check the most updated document online [click here](#)



TECHNICAL DATA

Series (mm)	25
Bore (mm)	20
Version	N = standard
Operation	2 = double acting
Materials	A = rolled stainless steel stem - stainless steel jacket
Construction	RL = cylinder with rod lock
Stroke type	standard
Stroke (mm)	200
Rod seals material	= standard
Extended rod (mm)	0

Minicylinders - Series 16 - 23 - 24 - 25

Product code: 25N2A20RL200

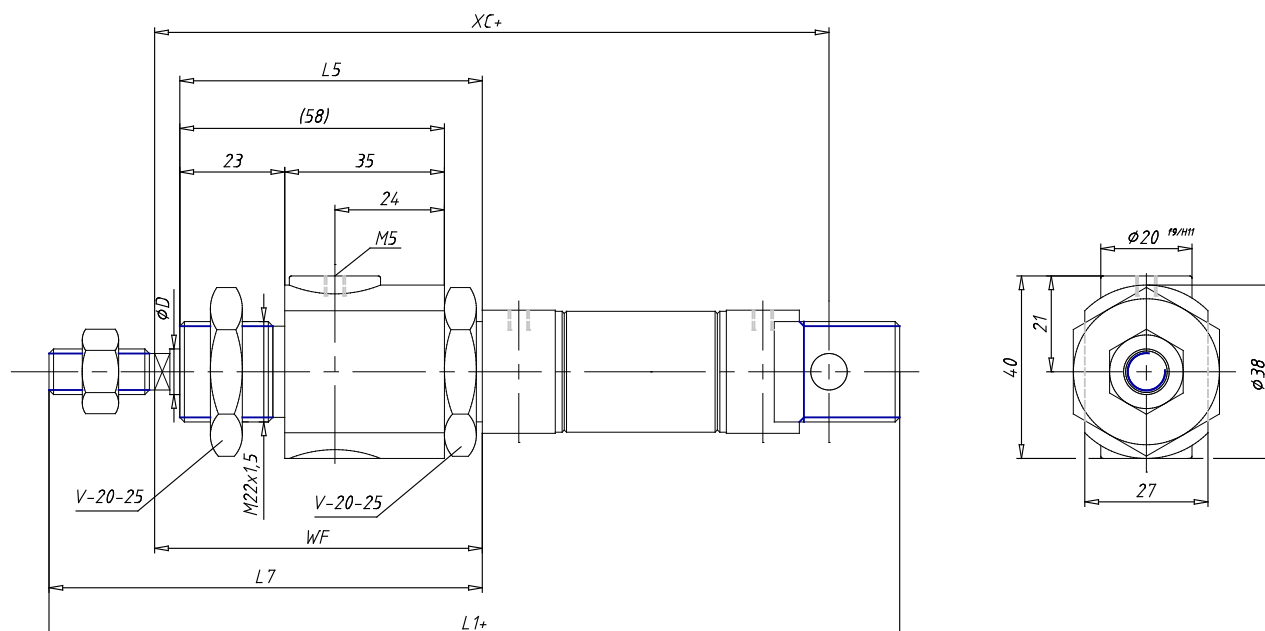

DIMENSIONS

EW (mm)	16
KW (mm)	10
BE	M22x1,5
KK	M8x1,25
$\varnothing CD$ (mm)	8
D1 (mm)	22.0
EE	G1/8
$\varnothing D2$ (mm)	8
L1 (mm)	382.0
XC (mm)	345
L2 (mm)	268.0
AM (mm)	20
L3 (mm)	18
L4 (mm)	8.0
L5 (mm)	70
L (mm)	12
WF (mm)	74
L6 (mm)	16
L7 (mm)	94
KV (mm)	32
SW (mm)	7
D (mm)	27.0
D3 (mm)	27