

Round cylinders - Series 27

Product code: 27M2A40A0320

Datasheet creation date: 07/03/2025 19:08

Check the most updated document online [click here](#)



TECHNICAL DATA

Series	27
Diameter (mm)	40
Version	M = rear end block upper round part
Operation	2 = double - acting
Materials	A = rolled stainless steel
Construction	A = standard
Stroke type	standard
Stroke (mm)	320

Round cylinders - Series 27

Product code: 27M2A40A0320

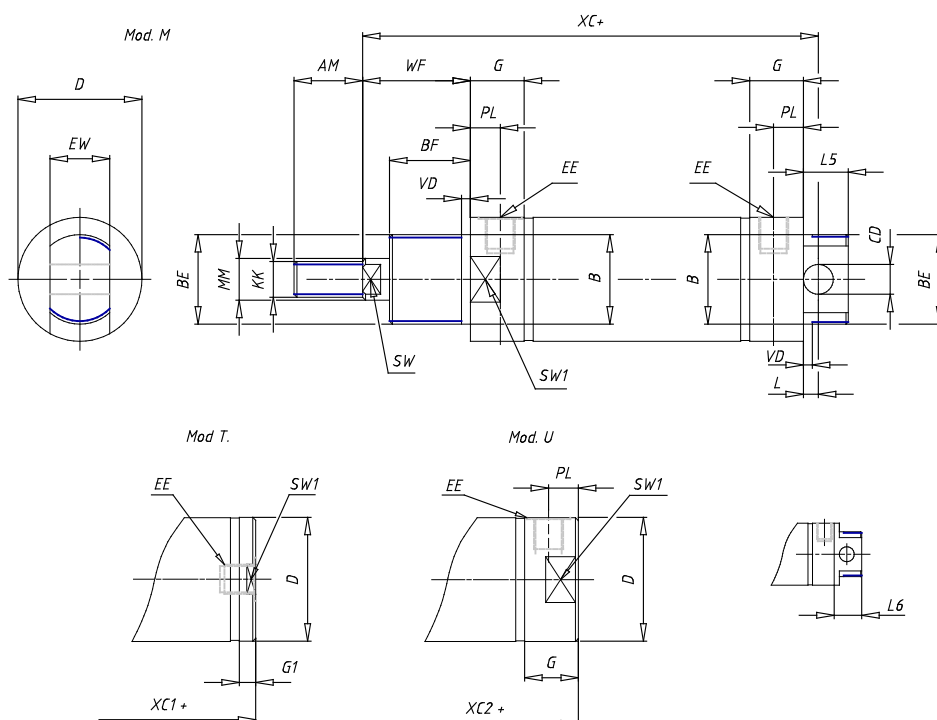

DIMENSIONS

AM (mm)	23
Ø B (mm)	30
BF (mm)	15
BE	M30x1.5
Ø CD (mm)	10
Ø D (mm)	41.5
EE	G1/8
EW (mm)	20
G (mm)	18.0
G1 (mm)	5.5
KK	M12x1.25
L (mm)	5
Ø MM (mm)	16
L5 (mm)	15
L6 (mm)	24
PL (mm)	10
SW (mm)	13
VD (mm)	3
WF (mm)	24.0
XC (mm)	96.0
XC1 (mm)	78.5
XC2 (mm)	91.0
SW1 (mm)	38

BG (mm)	0
BG1 (mm)	0.0
FB	0
RT	0
Ø RT1 (mm)	0
TC (mm)	0
TF (mm)	0.0