

Round cylinders - Series 27

Product code: 27U2A32A0600

Datasheet creation date: 07/03/2025 19:16

Check the most updated document online [click here](#)



TECHNICAL DATA

Series	27
Diameter (mm)	32
Version	U = rear end block upper round part
Operation	2 = double - acting
Materials	A = rolled stainless steel
Construction	A = standard
Stroke type	standard
Stroke (mm)	600

Round cylinders - Series 27

Product code: 27U2A32A0600

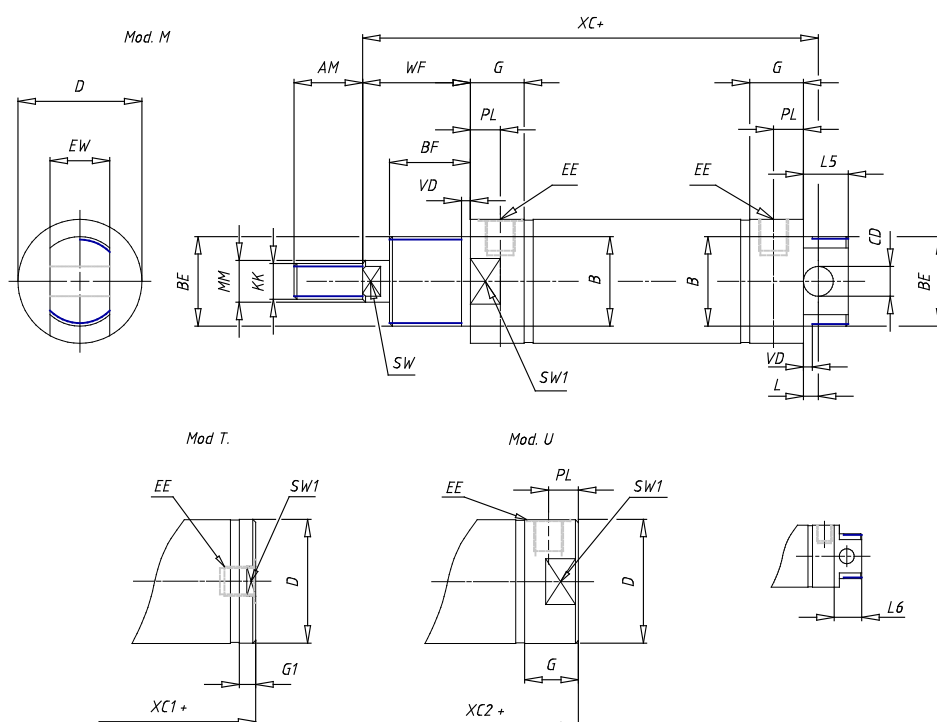

DIMENSIONS

AM (mm)	22
Ø B (mm)	22
BF (mm)	15
BE	M22x1.5
Ø CD (mm)	8
Ø D (mm)	33.5
EE	G1/8
EW (mm)	16
G (mm)	17.5
G1 (mm)	5.5
KK	M10x1.25
L (mm)	7
Ø MM (mm)	12
L5 (mm)	15
L6 (mm)	20
PL (mm)	9
SW (mm)	10
VD (mm)	3
WF (mm)	23.0
XC (mm)	93.0
XC1 (mm)	74.0
XC2 (mm)	86.0
SW1 (mm)	30

BG (mm)	0
BG1 (mm)	0.0
FB	0
RT	0
Ø RT1 (mm)	0
TC (mm)	0
TF (mm)	0.0