

## Round cylinders - Series 27

Product code: 27U2A50A0075

Datasheet creation date: 07/03/2025 19:18

Check the most updated document online [click here](#)



### TECHNICAL DATA

<b>Series</b>	27
<b>Diameter (mm)</b>	50
<b>Version</b>	U = rear end block upper round part
<b>Operation</b>	2 = double - acting
<b>Materials</b>	A = rolled stainless steel
<b>Construction</b>	A = standard
<b>Stroke type</b>	variable
<b>Stroke (mm)</b>	75

## Round cylinders - Series 27

Product code: 27U2A50A0075

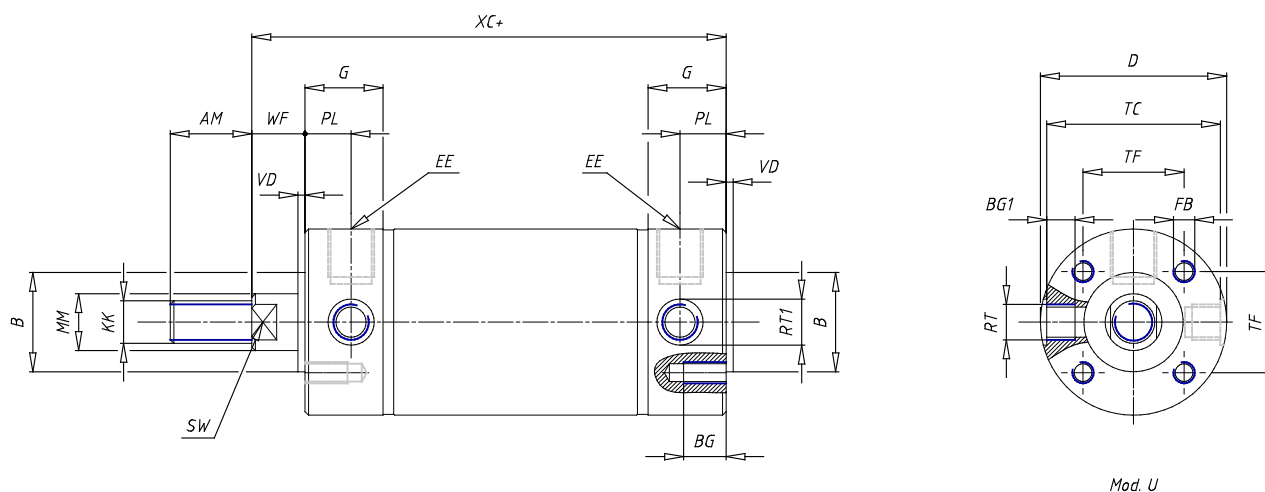

### DIMENSIONS

AM (mm)	23
Ø B (mm)	28
BF (mm)	0
BE	0
Ø CD (mm)	0
Ø D (mm)	52.5
EE	G1/4
EW (mm)	0
G (mm)	22.0
G1 (mm)	0.0
KK	M12x1.25
L (mm)	0
Ø MM (mm)	16
L5 (mm)	0
L6 (mm)	0
PL (mm)	13
SW (mm)	13
VD (mm)	2
WF (mm)	13.0
XC (mm)	97.0
XC1 (mm)	0.0
XC2 (mm)	0.0
SW1 (mm)	0

BG (mm)	12
BG1 (mm)	8.0
FB	M6
RT	M10x1
Ø RT1 (mm)	13
TC (mm)	49
TF (mm)	28.5