

Round cylinders - Series 27

Product code: 27U2A63A0625

Datasheet creation date: 07/03/2025 19:21

Check the most updated document online [click here](#)



TECHNICAL DATA

Series	27
Diameter (mm)	63
Version	U = rear end block upper round part
Operation	2 = double - acting
Materials	A = rolled stainless steel
Construction	A = standard
Stroke type	variable
Stroke (mm)	625

Round cylinders - Series 27

Product code: 27U2A63A0625

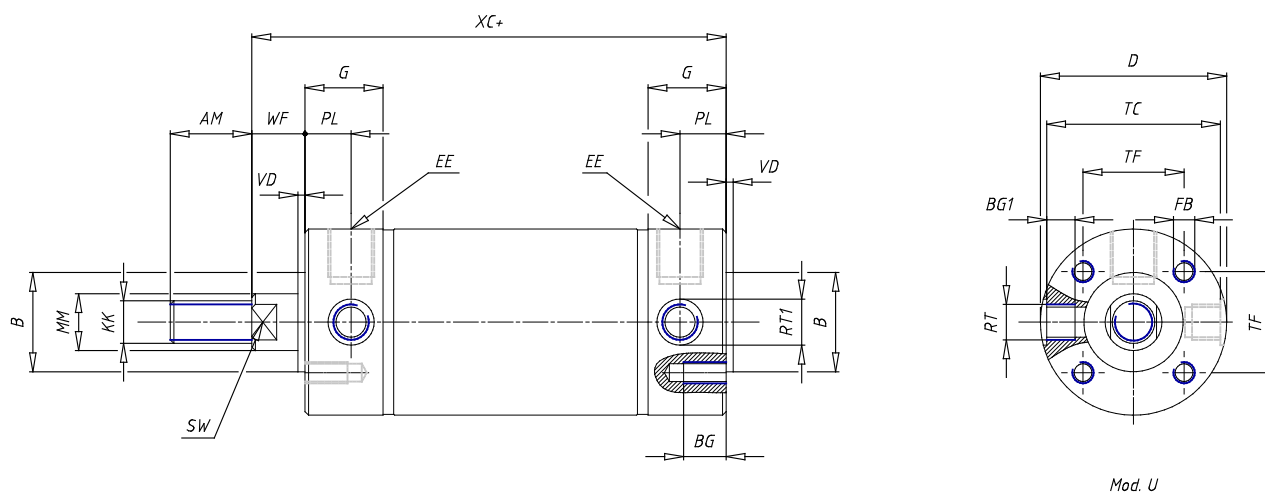

DIMENSIONS

AM (mm)	30
Ø B (mm)	35
BF (mm)	0
BE	0
Ø CD (mm)	0
Ø D (mm)	65.5
EE	G1/4
EW (mm)	0
G (mm)	22.0
G1 (mm)	0.0
KK	M16x1.5
L (mm)	0
Ø MM (mm)	20
L5 (mm)	0
L6 (mm)	0
PL (mm)	13
SW (mm)	17
VD (mm)	2
WF (mm)	13.0
XC (mm)	99.0
XC1 (mm)	0.0
XC2 (mm)	0.0
SW1 (mm)	0

BG (mm)	12
BG1 (mm)	9.5
FB	M8
RT	M12x1.5
Ø RT1 (mm)	15
TC (mm)	62
TF (mm)	35.5