

Valves - Series 28

Product code: 2820 3/8

Datasheet creation date: 10/03/2025 12:15

Check the most updated document online [click here](#)



TECHNICAL DATA

Mod.	2820 3/8
------	----------

Valves - Series 28

Product code: 2820 3/8

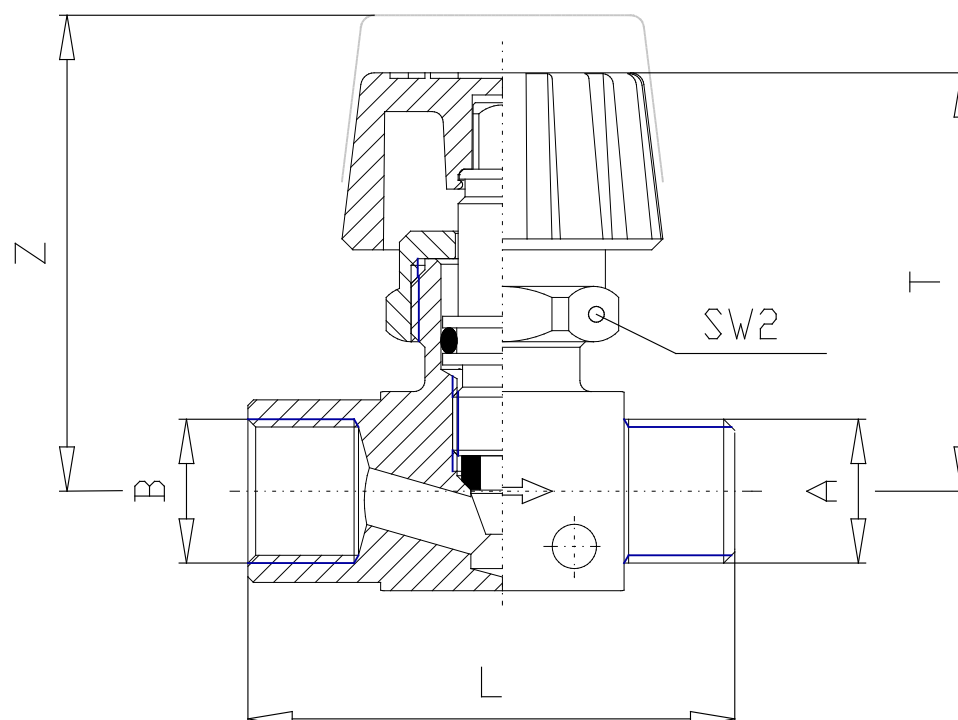

DIMENSIONS

A	G3/8
P	-
S	-
T (mm)	41.5
Z (mm)	48.0
SMAX	-
SW2	22
SW3	-