

## Compact cylinders - Series 31

Product code: 31F2A020A015W

Datasheet creation date: 07/03/2025 19:45

Check the most updated document online [click here](#)



### TECHNICAL DATA

<b>Series</b>	31
<b>Version</b>	F=female rod thread
<b>Operation</b>	2=double-acting
<b>Diameter (mm)</b>	20
<b>Stroke type</b>	standard
<b>Stroke (mm)</b>	15
<b>Rod seals material</b>	W = seals in FKM for high temperatures (140°C),
<b>Materials</b>	A = rolled stainless steel AISI 303 rod tube profile aluminium
<b>Construction</b>	A = standard

## Compact cylinders - Series 31

Product code: 31F2A020A015W

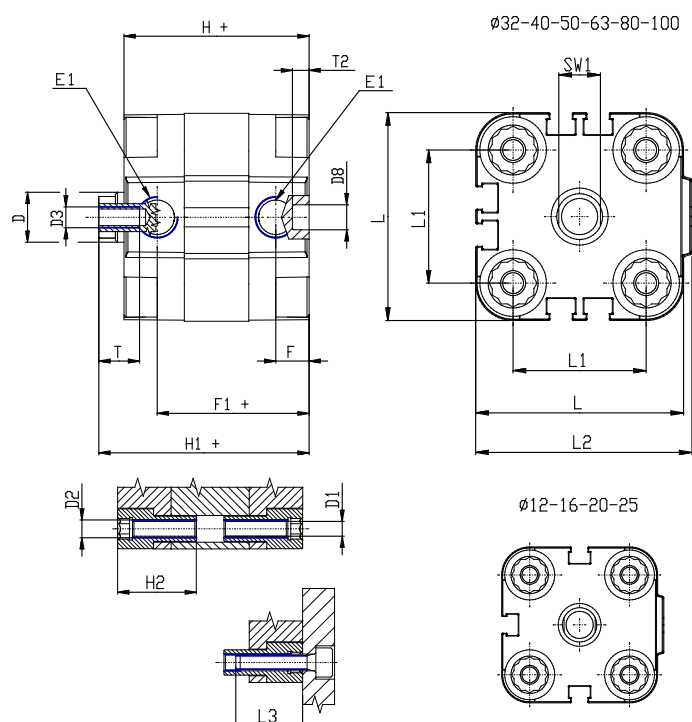

### DIMENSIONS

Ø D (mm)	10
Ø D1 (mm)	4.5
D2	M5
D3	M5
Ø D4 (mm)	4
D5	M4
Ø D8 (mm)	6
D9 (mm)	6
D10 (mm)	10
E1	M5
F (mm)	8.0
F1 (mm)	30.0
H (mm)	38.0
H1 (mm)	42.5
H2 (mm)	18.5
K1	M10x1,25
L (mm)	36
L1 (mm)	22
L2 (mm)	37.5
L3 (mm)	18
L4 (mm)	12.0
T (mm)	10
T1 (mm)	22

T2 (mm)	4
SW1 (mm)	8