

Compact cylinders - Series 31

Product code: 31F2A050A045

Datasheet creation date: 07/03/2025 19:59

Check the most updated document online [click here](#)



TECHNICAL DATA

Series	31
Version	F=female rod thread
Operation	2=double-acting
Diameter (mm)	50
Stroke type	variable
Stroke (mm)	45
Rod seals material	-
Materials	A = rolled stainless steel AISI 303 rod tube profile aluminium
Construction	A = standard

Compact cylinders - Series 31

Product code: 31F2A050A045

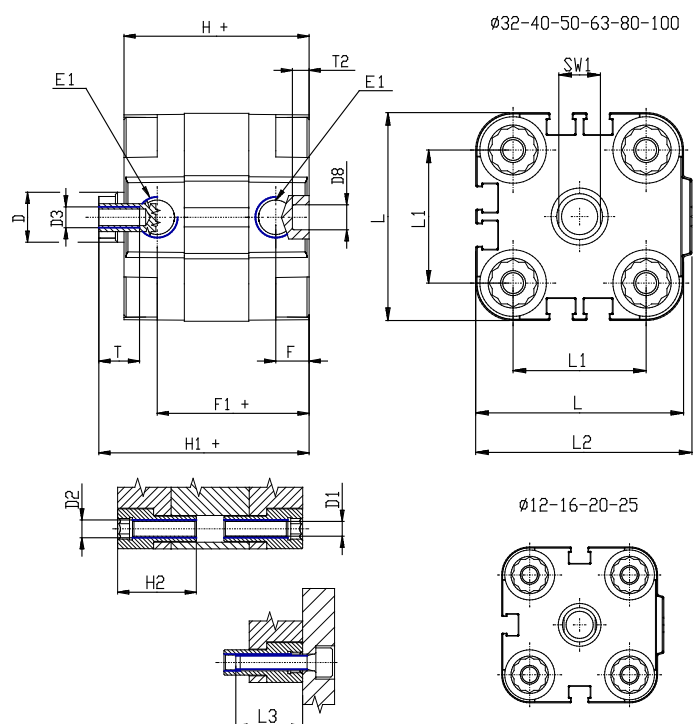

DIMENSIONS

Ø D (mm)	16
Ø D1 (mm)	6.5
D2	M8
D3	M8
Ø D4 (mm)	6
D5	M6
Ø D8 (mm)	6
D9 (mm)	10
D10 (mm)	22
E1	G1\8
F (mm)	8.0
F1 (mm)	37.5
H (mm)	45.5
H1 (mm)	53.0
H2 (mm)	22.5
K1	M12x1,25
L (mm)	68
L1 (mm)	50
L2 (mm)	71.0
L3 (mm)	20
L4 (mm)	29.7
T (mm)	12
T1 (mm)	24

T2 (mm)	4
SW1 (mm)	13