

## Compact cylinders, Multi-position versions - Series 31

Product code: 31F2A063A15/35N

Datasheet creation date: 07/03/2025 21:44

Check the most updated document online [click here](#)



### TECHNICAL DATA

<b>Series</b>	31
<b>Version</b>	F=female rod thread
<b>Operation</b>	2 = double-acting
<b>Materials</b>	A = rolled stainless steel AISI 303 rod tube profile aluminium
<b>Diameter (mm)</b>	63
<b>Construction</b>	A = standard
<b>Stages</b>	2 = 2 stages
<b>Stroke cylinder 1 (mm)</b>	15
<b>Stroke cylinder 2 (mm)</b>	35
<b>Stroke cylinder 3 (mm)</b>	0
<b>Stroke cylinder 4 (mm)</b>	0

## Compact cylinders, Multi-position versions - Series 31

Product code: 31F2A063A15/35N

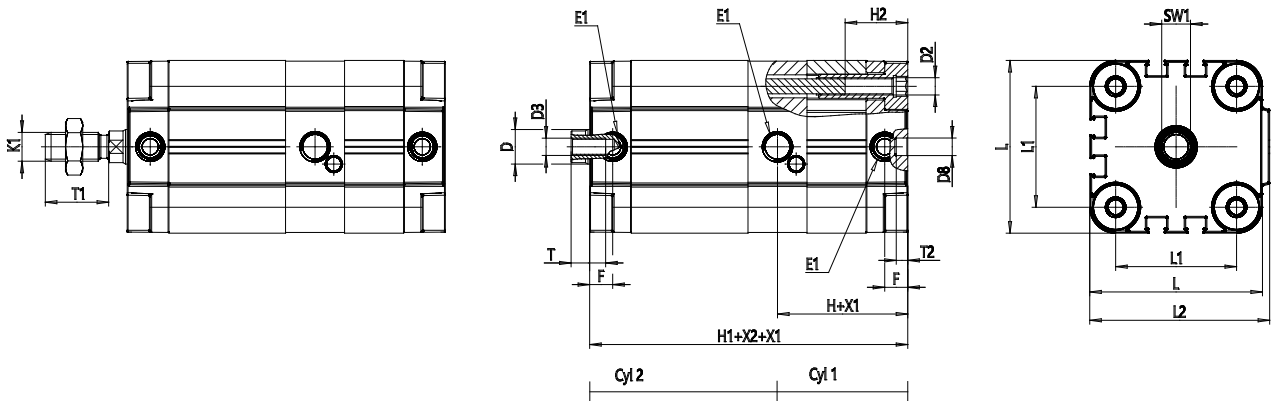

### DIMENSIONS

ØD (mm)	16
ØD1 (mm)	8.5
D2	M10
D3	M8
D4 (mm)	6
D5	M6
ØD8 (mm)	8
D9 (mm)	10
D10 (mm)	22
E1	G1\8
F (mm)	8.0
F1 (mm)	42.0
FX (mm)	14.5
H (mm)	50.0
H1 (mm)	100.5
H2 (mm)	26.0
H3 (mm)	81.5
H4 (mm)	0.0
K1	M12x1,25
L (mm)	87
L1 (mm)	62
L2 (mm)	91.0
L3 (mm)	25

L4 (mm)	35.4
T (mm)	12
T1 (mm)	24
T2 (mm)	4
SW1 (mm)	13
SWK (mm)	14