

## Compact cylinders - Series 31

Product code: 31F3A080A030

Datasheet creation date: 07/03/2025 20:07

Check the most updated document online [click here](#)



### TECHNICAL DATA

<b>Series</b>	31
<b>Version</b>	F=female rod thread
<b>Operation</b>	3=double-acting through rod
<b>Diameter (mm)</b>	80
<b>Stroke type</b>	standard
<b>Stroke (mm)</b>	30
<b>Rod seals material</b>	-
<b>Materials</b>	A = rolled stainless steel AISI 303 rod tube profile aluminium
<b>Construction</b>	A = standard

## Compact cylinders - Series 31

Product code: 31F3A080A030

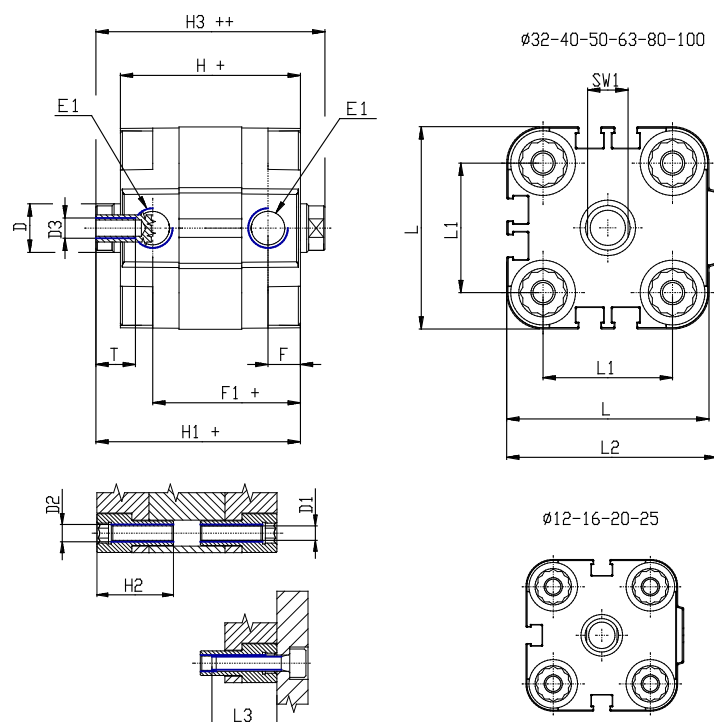

### DIMENSIONS

Ø D (mm)	20
Ø D1 (mm)	8.5
D2	M10
D3	M10
Ø D4 (mm)	8
D5	M8
Ø D8 (mm)	8
D9 (mm)	12
D10 (mm)	28
E1	G1/8
F (mm)	8.5
F1 (mm)	47.5
H (mm)	56.0
H1 (mm)	64.0
H2 (mm)	24.5
K1	M16x1,5
L (mm)	107
L1 (mm)	82
L2 (mm)	111.0
L3 (mm)	25
L4 (mm)	46.0
T (mm)	16
T1 (mm)	32

T2 (mm)	4
SW1 (mm)	17