

Compact cylinders, Multi-position versions - Series 31

Product code: 31M2A032A10/25N

Datasheet creation date: 07/03/2025 21:17

Check the most updated document online [click here](#)



TECHNICAL DATA

Series	31
Version	M=male rod thread
Operation	2 = double-acting
Materials	A = rolled stainless steel AISI 303 rod tube profile aluminium
Diameter (mm)	32
Construction	A = standard
Stages	2 = 2 stages
Stroke cylinder 1 (mm)	10
Stroke cylinder 2 (mm)	25
Stroke cylinder 3 (mm)	0
Stroke cylinder 4 (mm)	0

Compact cylinders, Multi-position versions - Series 31

Product code: 31M2A032A10/25N

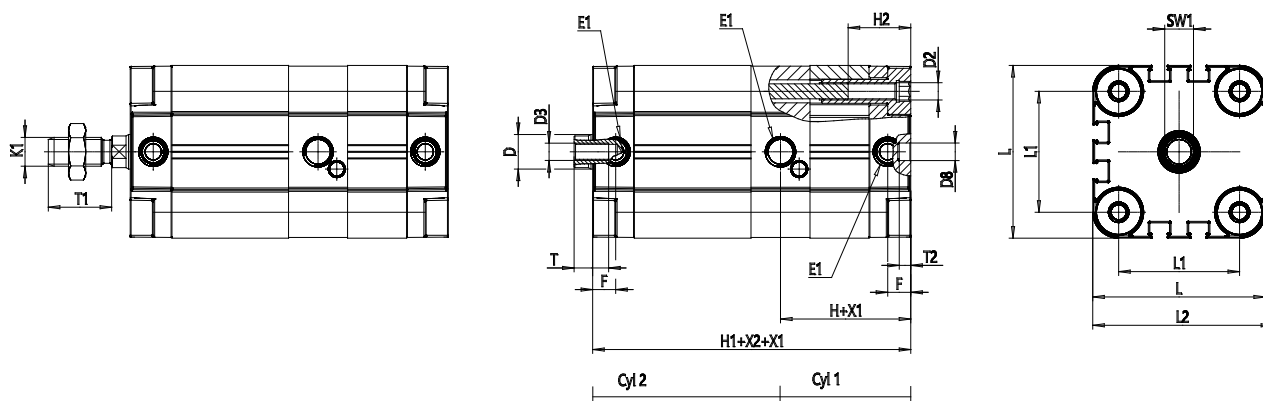

DIMENSIONS

ØD (mm)	12
ØD1 (mm)	5.5
D2	M6
D3	M6
D4 (mm)	5
D5	M5
ØD8 (mm)	6
D9 (mm)	6
D10 (mm)	17
E1	G1\8
F (mm)	8.0
F1 (mm)	36.5
FX (mm)	14.5
H (mm)	46.5
H1 (mm)	90.5
H2 (mm)	21.5
H3 (mm)	72.5
H4 (mm)	0.0
K1	M10x1,25
L (mm)	50
L1 (mm)	32
L2 (mm)	52.0
L3 (mm)	20

L4 (mm)	19.8
T (mm)	12
T1 (mm)	22
T2 (mm)	4
SW1 (mm)	10
SWK (mm)	10