

Compact cylinders, Multi-position versions - Series 31

Product code: 31M2A050A30/75N

Datasheet creation date: 07/03/2025 21:41

Check the most updated document online [click here](#)



TECHNICAL DATA

Series	31
Version	M=male rod thread
Operation	2 = double-acting
Materials	A = rolled stainless steel AISI 303 rod tube profile aluminium
Diameter (mm)	50
Construction	A = standard
Stages	2 = 2 stages
Stroke cylinder 1 (mm)	30
Stroke cylinder 2 (mm)	75
Stroke cylinder 3 (mm)	0
Stroke cylinder 4 (mm)	0

Compact cylinders, Multi-position versions - Series 31

Product code: 31M2A050A30/75N

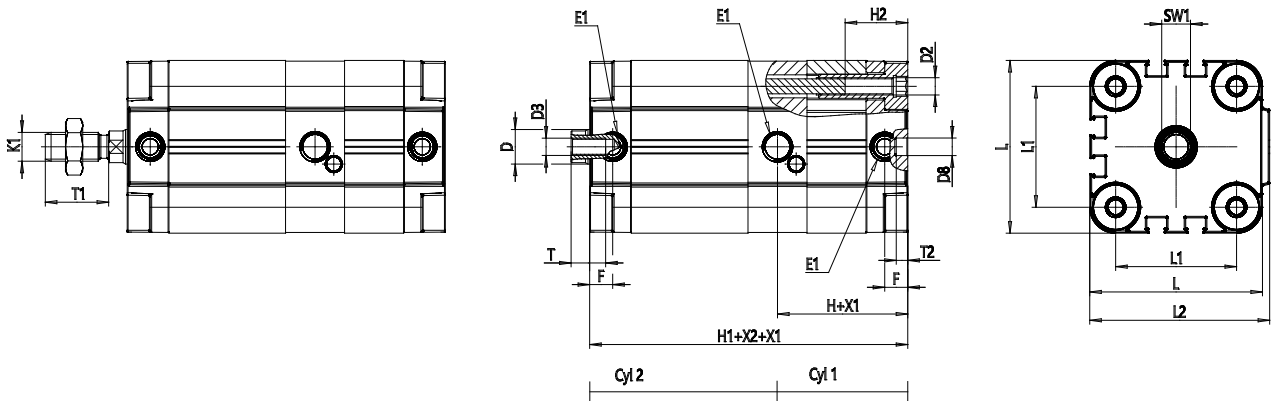

DIMENSIONS

ØD (mm)	16
ØD1 (mm)	6.5
D2	M8
D3	M8
D4 (mm)	6
D5	M6
ØD8 (mm)	6
D9 (mm)	10
D10 (mm)	22
E1	G1\8
F (mm)	8.0
F1 (mm)	37.5
FX (mm)	14.5
H (mm)	47.0
H1 (mm)	90.5
H2 (mm)	18.0
H3 (mm)	77.0
H4 (mm)	0.0
K1	M12x1,25
L (mm)	68
L1 (mm)	50
L2 (mm)	71.0
L3 (mm)	20

L4 (mm)	29.7
T (mm)	12
T1 (mm)	24
T2 (mm)	4
SW1 (mm)	13
SWK (mm)	10