

Compact cylinders, Multi-position versions - Series 31

Product code: 31M2A080A20/60N

Datasheet creation date: 07/03/2025 21:55

Check the most updated document online [click here](#)



TECHNICAL DATA

| | |
|-------------------------------|--|
| Series | 31 |
| Version | M=male rod thread |
| Operation | 2 = double-acting |
| Materials | A = rolled stainless steel AISI 303 rod tube profile aluminium |
| Diameter (mm) | 80 |
| Construction | A = standard |
| Stages | 2 = 2 stages |
| Stroke cylinder 1 (mm) | 20 |
| Stroke cylinder 2 (mm) | 60 |
| Stroke cylinder 3 (mm) | 0 |
| Stroke cylinder 4 (mm) | 0 |

Compact cylinders, Multi-position versions - Series 31

Product code: 31M2A080A20/60N

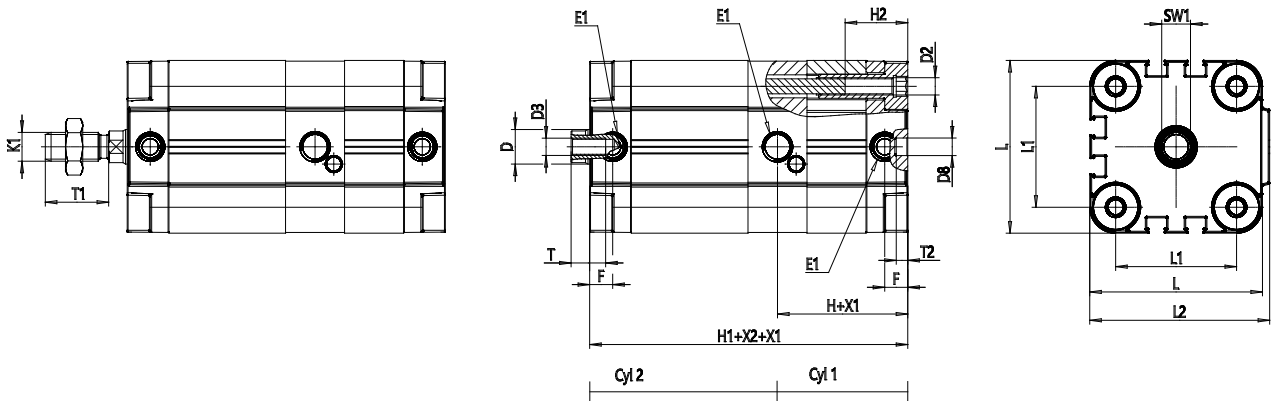

DIMENSIONS

| | |
|----------|---------|
| ØD (mm) | 20 |
| ØD1 (mm) | 8.5 |
| D2 | M10 |
| D3 | M10 |
| D4 (mm) | 8 |
| D5 | M8 |
| ØD8 (mm) | 8 |
| D9 (mm) | 12 |
| D10 (mm) | 28 |
| E1 | G1\8 |
| F (mm) | 8.5 |
| F1 (mm) | 47.5 |
| FX (mm) | 16.5 |
| H (mm) | 59.0 |
| H1 (mm) | 112.0 |
| H2 (mm) | 26.5 |
| H3 (mm) | 96.0 |
| H4 (mm) | 0.0 |
| K1 | M16x1,5 |
| L (mm) | 107 |
| L1 (mm) | 82 |
| L2 (mm) | 111.0 |
| L3 (mm) | 25 |

| | |
|----------|------|
| L4 (mm) | 46.0 |
| T (mm) | 16 |
| T1 (mm) | 32 |
| T2 (mm) | 4 |
| SW1 (mm) | 17 |
| SWK (mm) | 14 |