

## Compact cylinders, Multi-position versions - Series 31

Product code: 31M2A080A60/125N

Datasheet creation date: 07/03/2025 21:56

Check the most updated document online [click here](#)



### TECHNICAL DATA

<b>Series</b>	31
<b>Version</b>	M=male rod thread
<b>Operation</b>	2 = double-acting
<b>Materials</b>	A = rolled stainless steel AISI 303 rod tube profile aluminium
<b>Diameter (mm)</b>	80
<b>Construction</b>	A = standard
<b>Stages</b>	2 = 2 stages
<b>Stroke cylinder 1 (mm)</b>	60
<b>Stroke cylinder 2 (mm)</b>	125
<b>Stroke cylinder 3 (mm)</b>	0
<b>Stroke cylinder 4 (mm)</b>	0

## Compact cylinders, Multi-position versions - Series 31

Product code: 31M2A080A60/125N

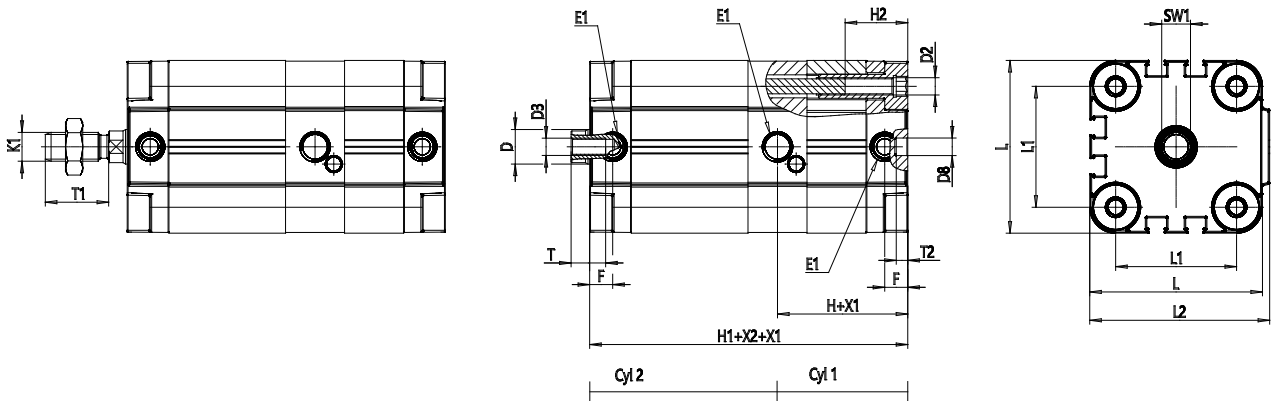

### DIMENSIONS

ØD (mm)	20
ØD1 (mm)	8.5
D2	M10
D3	M10
D4 (mm)	8
D5	M8
ØD8 (mm)	8
D9 (mm)	12
D10 (mm)	28
E1	G1\8
F (mm)	8.5
F1 (mm)	47.5
FX (mm)	16.5
H (mm)	59.0
H1 (mm)	112.0
H2 (mm)	26.5
H3 (mm)	96.0
H4 (mm)	0.0
K1	M16x1,5
L (mm)	107
L1 (mm)	82
L2 (mm)	111.0
L3 (mm)	25

L4 (mm)	46.0
T (mm)	16
T1 (mm)	32
T2 (mm)	4
SW1 (mm)	17
SWK (mm)	14