

## Compact cylinders - Series 31

Product code: 31M3A012A005

Datasheet creation date: 07/03/2025 20:12

Check the most updated document online [click here](#)



### TECHNICAL DATA

<b>Series</b>	31
<b>Version</b>	M=male rod thread
<b>Operation</b>	3=double-acting through rod
<b>Diameter (mm)</b>	12
<b>Stroke type</b>	standard
<b>Stroke (mm)</b>	5
<b>Rod seals material</b>	-
<b>Materials</b>	A = rolled stainless steel AISI 303 rod tube profile aluminium
<b>Construction</b>	A = standard

## Compact cylinders - Series 31

Product code: 31M3A012A005

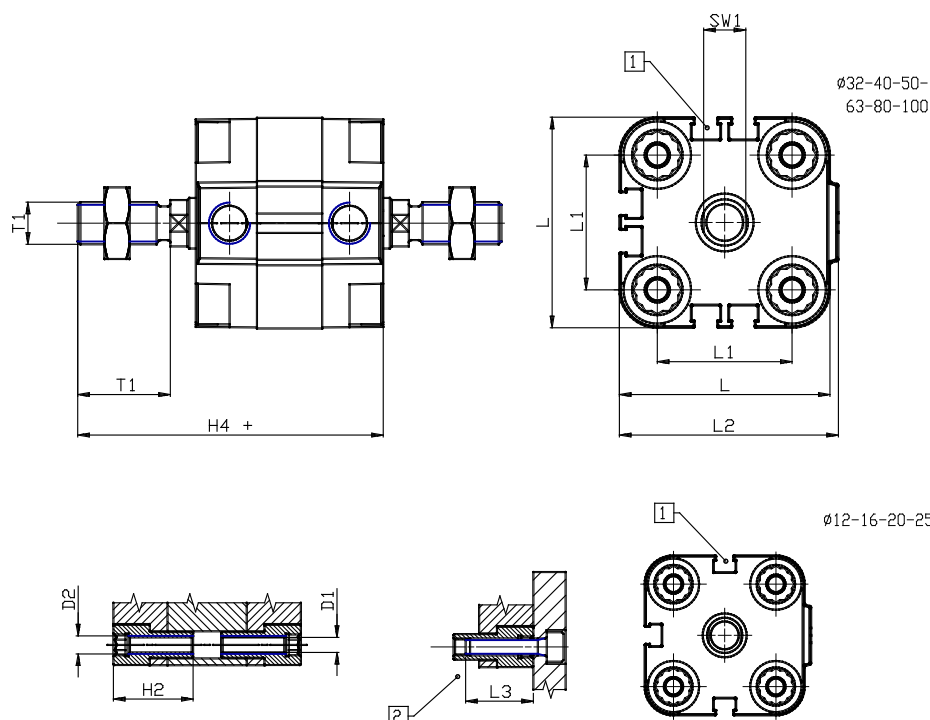

### DIMENSIONS

Ø D (mm)	6
Ø D1 (mm)	3.5
D2	M4
D3	M3
Ø D4 (mm)	3
D5	M3
Ø D8 (mm)	6
D9 (mm)	5
D10 (mm)	6
E1	M5
F (mm)	8.0
F1 (mm)	30.0
H (mm)	38.0
H1 (mm)	42.5
H2 (mm)	18.5
K1	M6
L (mm)	29
L1 (mm)	18
L2 (mm)	30.0
L3 (mm)	16
L4 (mm)	9.9
T (mm)	6
T1 (mm)	16

T2 (mm)	4
SW1 (mm)	5