

## Compact cylinders - Series 31

Product code: 31M3A032A125

Datasheet creation date: 07/03/2025 20:28

Check the most updated document online [click here](#)



### TECHNICAL DATA

<b>Series</b>	31
<b>Version</b>	M=male rod thread
<b>Operation</b>	3=double-acting through rod
<b>Diameter (mm)</b>	32
<b>Stroke type</b>	variable
<b>Stroke (mm)</b>	125
<b>Rod seals material</b>	-
<b>Materials</b>	A = rolled stainless steel AISI 303 rod tube profile aluminium
<b>Construction</b>	A = standard

## Compact cylinders - Series 31

Product code: 31M3A032A125

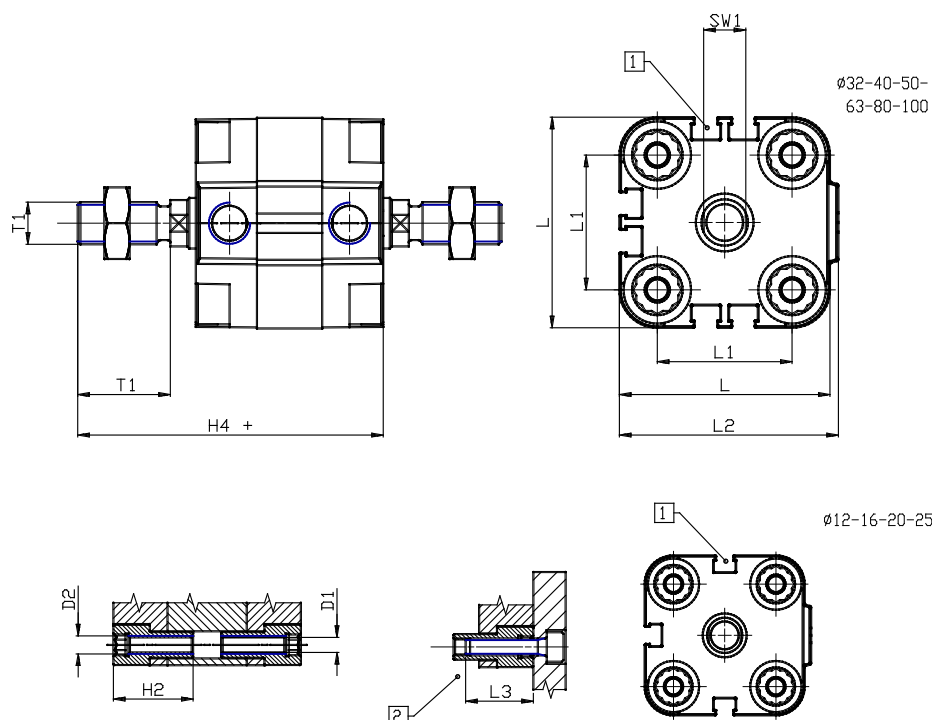

### DIMENSIONS

Ø D (mm)	12
Ø D1 (mm)	5.5
D2	M6
D3	M6
Ø D4 (mm)	5
D5	M5
Ø D8 (mm)	6
D9 (mm)	6
D10 (mm)	17
E1	G1\8
F (mm)	8.0
F1 (mm)	36.5
H (mm)	44.5
H1 (mm)	50.5
H2 (mm)	21.5
K1	M10x1,25
L (mm)	50
L1 (mm)	32
L2 (mm)	52.0
L3 (mm)	20
L4 (mm)	19.8
T (mm)	12
T1 (mm)	22

T2 (mm)	4
SW1 (mm)	10